



Prices effective February 5, 2018

Canvas Office Landscape® Group

Introduction	page 2
Canvas Office Landscape Group	3
Structure	5
Standing Screens	15
Indices	19
By Name	19
By Number	21
Appendices	
20-Day or Less/Assigned Lead-Time Order Information	
Vary Easy Program	
Fire Retardancy-Workspaces	
Stain-to-Match Program	
Canvas Office Landscape Connectors and Covers Matrix	
Customer's Own Material/Customer's Own Leather Order Information-Cushion Tops	
Customer's Own Material Order Information-Workspaces	
Proprietary Textiles Application Chart-Workspaces	
Proprietary Textile Colors-Workspaces	
Maharam® Application Chart-Workspaces	
Maharam Colors-Workspaces	
For the latest materials information, refer to the Materials pages on HermanMiller.com.	

Introduction

A Note on the Organization of This Book

There are a few signals that will help you understand the organization of this book. Once you know them, you should be able to find your way around easily.

Like a newspaper, this book is formatted with columns of text and illustrations that run vertically.

Information wraps from one column to the next and continues for as many pages as it needs to.

Black bars are clues.

A black bar at the top of a page signals the start of information about a product.

This information is divided into two sections, each signaled by a black bar. Product Information includes a description, additional notes, and dimensional drawings. Specification Information, which always begins at the top of a column, includes a series of steps. Each step represents a decision you need to make in order to complete your product number. Steps must be followed sequentially. The number of pages needed to complete information on a product varies; some will be complete in one page; others may fill three or four pages. Just continue going through the steps until you run into the next product, signaled by the black bar at the top of the page.

Black tabs running along the outside edge of the page help you locate what section you are in or what section you want to go to. You can thumb forwards or backwards to find a section; tabs and text appear on both sides of the page.

The additional pages in the back of the book include the appendices and indices. They are signaled by a long black bar running along the outside edge of the page.

The index is presented two ways.

The first index is in alphabetical order by product name. It can be helpful if you are new to the products and numbering scheme or if you are looking for a type of product, such as work chair or round table.

The second index is by product number. It lists, in alphanumeric order, the base product number, typically a five-digit number.

This book is effective February 5, 2018, subject to change without notice. Products may be purchased from authorized Herman Miller dealers who will quote prices upon request. For more information about our products and services or to see a list of dealers, visit www.HermanMiller.com.

All prices are list prices in US Dollars. Additional services, such as planning services, design, storage, and installation, are not included and must be added to these prices when the additional services are requested.

Illustrations, specifications, and prices are based on the latest information at the time of publication. The right is reserved to make changes at any time without notice in prices, fabrics, finishes, materials, specifications, and models, and also to discontinue models and finishes.

Dimensions shown in the drawings are engineering drawing dimensions rounded up to the nearest $\frac{1}{8}$ ". Product is shipped set up or knocked down. Products that include "Shipped knocked down" in the description require some assembly. If this statement does not appear in the description, the product is shipped assembled.

Service problems are normally handled by a Herman Miller authorized dealer. Where this cannot be accomplished on a local level, service problems should be referred to the Customer Care Representative for your region, Herman Miller, Inc., Zeeland, Michigan 49464.

20-Day or Less/Assigned Lead-Time Shipments

All products and options in this price book not designated by an Assigned Program icon  will ship in **20 business days or less** after being acknowledged by Herman Miller.

Products and options designated by an  are on the assigned lead-time program and may ship in 20 days, less than 20 days, or more than 20 days from order acknowledgement.

Structure

Standing Screens



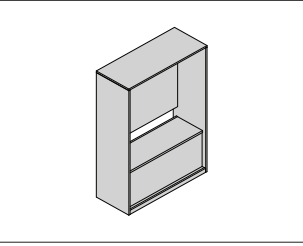

Product Information

Description

This 68" tall, 20" deep freestanding wall can be used independently or with the team wall (FC110). It has a 2 1/4" base with 1" leveling glides. The case and shelf are available in laminate or veneer. It has a removable bottom door to allow easy access to the internal storage compartment. A vertical cable management chase extends from bottom of the unit to the top shelf. A back panel maintains a 6" opening at the top of the case and a 5" gap at mid level.

Notes

Ganging hardware is included.

Order peninsula, team wall, technology module (FCS60) separately.

Integrated 6-outlet power strip in base must be hardwired.

When shelves are wood grain laminate or veneer, stanchion cover is anodized aluminum.

Dimensions

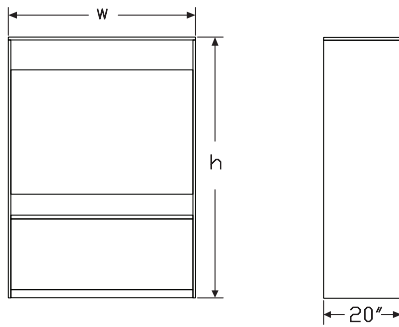

Specification Information

Step 1.

FC100. [A]

Step 2. Height

68 68" high [A]

Step 3. Width

48 48" wide [A]

Step 4. Technology Display Height

SP seated-height display, for use with peninsula [A]

TP standing-height display, for use with peninsula [A]

SN seated-height display, no peninsula [A]

TN standing-height display, no peninsula [A]

Step 5. Case Material

L laminate [A]

W veneer [A]

Step 6. Shelf/Technology Door Material

L laminate [A]

W veneer [A]

LX laminate shelves - metal perforated door [A]

WX veneer shelves - metal perforated door [A]

Prices for Steps 1-6.

	SPLL	SPLW	SPLLX	SPLWX	SPWL	SPWW	
FC100. 68 48	\$4644	4644	4644	4644	8700	8700	
	SPWLX	SPWWX	TPLL	TPLW	TPLLX	TPLWX	
FC100. 68 48	\$8700	8700	4644	4644	4644	4644	
	TPWL	TPWW	TPWLX	TPWWX	SNLL	SNLW	
FC100. 68 48	\$8700	8700	8700	8700	4644	4644	
	SNLLX	SNLWX	SNWL	SNWW	SNWLX	SNWWX	
FC100. 68 48	\$4644	4644	8700	8700	8700	8700	
	TNLL	TNLW	TNLLX	TNLWX	TNWL	TNWW	
FC100. 68 48	\$4644	4644	4644	4644	8700	8700	
						TNWLX	TNWWX
FC100. 68 48						\$8700	8700

Team Wall, Technology Module

continued

Canvas Office Landscape® Structure

Step 7. Power

P	power strip A	+\$0
A	modular power cord w/ plug end A	+\$0

Step 8. Case Finish

Solid-Color Laminate

For laminate (L)

8Q	folkstone grey A	+\$0
91	white A	+\$0
98	studio white	+\$0
CL	cool grey neutral A	+\$0
LU	soft white A	+\$0
WL	sandstone A	+\$0
WN	warm grey neutral A	+\$0

Linen Laminate

For laminate (L)

LBM	crisp linen	+\$0
LBN	classic linen	+\$0
LBP	casual linen	+\$0

Mesh Laminate

For laminate (L)

LBK	pewter mesh	+\$0
LBL	steel mesh	+\$0

Twill Laminate

For laminate (L)

LBF	neutral twill	+\$0
LBG	sarum twill	+\$0
LBH	earthen twill	+\$0
LBJ	graphite twill	+\$0
LBQ	white twill	+\$0

Wood-Grain Laminate

For laminate (L)

HM	natural maple A	+\$0
HP	light anigre A	+\$0
LBA	clear on ash	+\$0
LBB	oak on ash	+\$0
LBC	walnut on ash	+\$0
LBD	dark brown walnut	+\$0
LBE	medium red walnut	+\$0
76	light brown walnut A	+\$0
HX	aged cherry A	+\$0
HY	walnut on cherry A	+\$0

Wood Veneer

For veneer (W)

2U	light brown walnut A	+\$0
40	dark brown walnut A	+\$0
ED	aged cherry A	+\$0
EK	medium red walnut A	+\$0
ET	clear on ash A	+\$0
EU	oak on ash A	+\$0
EV	walnut on ash A	+\$0
UL	natural maple A	+\$0
UX	walnut on cherry A	+\$0

Step 9. Shelf Finish

Solid-Color Laminate

For laminate (L) or laminate shelves - metal perforated door (LX)

8Q	folkstone grey A	+\$0
91	white A	+\$0
98	studio white	+\$0
CL	cool grey neutral A	+\$0
LU	soft white A	+\$0
WL	sandstone A	+\$0
WN	warm grey neutral A	+\$0

Linen Laminate

For laminate (L) or laminate shelves - metal perforated door (LX)

LBM	crisp linen	+\$0
LBN	classic linen	+\$0
LBP	casual linen	+\$0

Mesh Laminate

For laminate (L) or laminate shelves - metal perforated door (LX)

LBK	pewter mesh	+\$0
LBL	steel mesh	+\$0

Twill Laminate

For laminate (L) or laminate shelves - metal perforated door (LX)

LBF	neutral twill	+\$0
LBG	sarum twill	+\$0
LBH	earthen twill	+\$0
LBJ	graphite twill	+\$0
LBQ	white twill	+\$0

Team Wall, Technology Module

continued

Wood-Grain Laminate

For laminate (L) or laminate shelves - metal perforated door (LX)

HM	natural maple <input type="checkbox"/>	+\$0
HP	light anigre <input type="checkbox"/>	+\$0
LBA	clear on ash	+\$0
LBB	oak on ash	+\$0
LBC	walnut on ash	+\$0
LBD	dark brown walnut	+\$0
LBE	medium red walnut	+\$0
76	light brown walnut <input type="checkbox"/>	+\$60
HX	aged cherry <input type="checkbox"/>	+\$60
HY	walnut on cherry <input type="checkbox"/>	+\$60

Wood Veneer

For veneer (W) or veneer shelves - metal perforated door (WX)

2U	light brown walnut <input type="checkbox"/>	+\$0
40	dark brown walnut <input type="checkbox"/>	+\$0
ED	aged cherry <input type="checkbox"/>	+\$0
EK	medium red walnut <input type="checkbox"/>	+\$0
ET	clear on ash <input type="checkbox"/>	+\$0
EU	oak on ash <input type="checkbox"/>	+\$0
EV	walnut on ash <input type="checkbox"/>	+\$0
UL	natural maple <input type="checkbox"/>	+\$0
UX	walnut on cherry <input type="checkbox"/>	+\$0

Step 10. Metal Perforated Door Finish-paint

For laminate shelves - metal perforated door (LX) or veneer shelves - metal perforated door (WX)

91	white <input type="checkbox"/>	+\$0
CL	cool grey neutral <input type="checkbox"/>	+\$0
G1	graphite <input type="checkbox"/>	+\$0
WN	warm grey neutral <input type="checkbox"/>	+\$0
CN	metallic champagne <input type="checkbox"/>	+\$0
EH	metallic bronze <input type="checkbox"/>	+\$0
MS	metallic silver <input type="checkbox"/>	+\$0

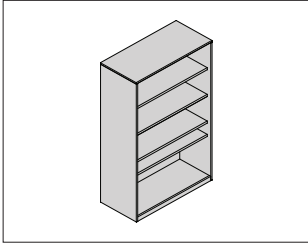

Product Information

Description
 This 68" tall, 20" deep freestanding wall can be used independently or with the team wall, technology module (FC100). It has a 2 1/4" base with 1" leveling glides. The case and shelf are available in laminate or veneer.

Notes
 Ganging hardware is included.
 Optional marker board doors are available.
 Use infill (FC111) to provide a marker board or tackboard on the backside of the wall. Infill will maintain a 6" opening at the top and 5" opening at mid level of wall.

Dimensions

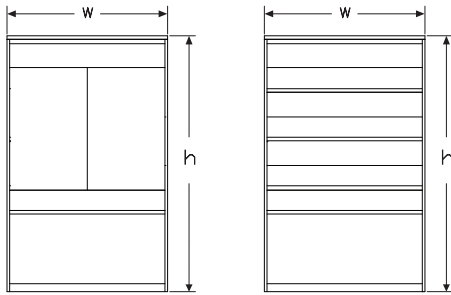

Specification Information

Step 1.

FC110. A

Step 2. Height

68 68" high A

Step 3. Width

42 42" wide A

Step 4. Upper Doors

N no upper doors A

D upper doors A

Step 5. Case Material

L laminate A

W veneer A

Step 6. Shelf

L laminate A

W veneer A

Prices for Steps 1-6.

	NLL	NLW	NWL	NWW	DLL	DLW
FC110. 68 42	\$3974	3974	8029	8029	4718	4718
					DWL	DWW
FC110. 68 42					\$8774	8774

Step 7. Shelf Orientation

For no upper doors (N)

1 All shelves facing forward A +\$0

2 Top, bottom shelf facing forward, middle shelf facing back A +\$0

3 Top, bottom shelf facing back, middle shelf facing forward A +\$0

For upper doors (D)

1 All shelves facing forward A +\$0

Step 8. Door Material

For upper doors (D)

MM marker board A +\$0

Step 9. Case Finish

Solid-Color Laminate		
<i>For laminate (L)</i>		
8Q	folkstone grey <input type="checkbox"/>	+\$0
91	white <input type="checkbox"/>	+\$0
98	studio white	+\$0
CL	cool grey neutral <input type="checkbox"/>	+\$0
LU	soft white <input type="checkbox"/>	+\$0
WL	sandstone <input type="checkbox"/>	+\$0
WN	warm grey neutral <input type="checkbox"/>	+\$0

Linen Laminate		
<i>For laminate (L)</i>		
LBM	crisp linen	+\$0
LBN	classic linen	+\$0
LBP	casual linen	+\$0

Mesh Laminate		
<i>For laminate (L)</i>		
LBK	pewter mesh	+\$0
LBL	steel mesh	+\$0

Twill Laminate		
<i>For laminate (L)</i>		
LBF	neutral twill	+\$0
LBG	sarum twill	+\$0
LBH	earthen twill	+\$0
LBJ	graphite twill	+\$0
LBQ	white twill	+\$0

Wood-Grain Laminate		
<i>For laminate (L)</i>		
HM	natural maple <input type="checkbox"/>	+\$0
HP	light anigre <input type="checkbox"/>	+\$0
LBA	clear on ash	+\$0
LBB	oak on ash	+\$0
LBC	walnut on ash	+\$0
LBD	dark brown walnut	+\$0
LBE	medium red walnut	+\$0
76	light brown walnut <input type="checkbox"/>	+\$0
HX	aged cherry <input type="checkbox"/>	+\$0
HY	walnut on cherry <input type="checkbox"/>	+\$0

Wood Veneer		
<i>For veneer (W)</i>		
2U	light brown walnut <input type="checkbox"/>	+\$0
40	dark brown walnut <input type="checkbox"/>	+\$0
ED	aged cherry <input type="checkbox"/>	+\$0
EK	medium red walnut <input type="checkbox"/>	+\$0
ET	clear on ash <input type="checkbox"/>	+\$0
EU	oak on ash <input type="checkbox"/>	+\$0
EV	walnut on ash <input type="checkbox"/>	+\$0
UL	natural maple <input type="checkbox"/>	+\$0
UX	walnut on cherry <input type="checkbox"/>	+\$0

Step 10. Shelf Finish

Solid-Color Laminate		
<i>For laminate (L)</i>		
8Q	folkstone grey <input type="checkbox"/>	+\$0
91	white <input type="checkbox"/>	+\$0
98	studio white	+\$0
CL	cool grey neutral <input type="checkbox"/>	+\$0
LU	soft white <input type="checkbox"/>	+\$0
WL	sandstone <input type="checkbox"/>	+\$0
WN	warm grey neutral <input type="checkbox"/>	+\$0

Linen Laminate		
<i>For laminate (L)</i>		
LBM	crisp linen	+\$0
LBN	classic linen	+\$0
LBP	casual linen	+\$0

Mesh Laminate		
<i>For laminate (L)</i>		
LBK	pewter mesh	+\$0
LBL	steel mesh	+\$0

Twill Laminate		
<i>For laminate (L)</i>		
LBF	neutral twill	+\$0
LBG	sarum twill	+\$0
LBH	earthen twill	+\$0
LBJ	graphite twill	+\$0
LBQ	white twill	+\$0

Wood-Grain Laminate

For laminate (L)

HM	natural maple <input type="checkbox"/> A	+\$0
HP	light anigre <input type="checkbox"/> A	+\$0
LBA	clear on ash	+\$0
LBB	oak on ash	+\$0
LBC	walnut on ash	+\$0
LBD	dark brown walnut	+\$0
LBE	medium red walnut	+\$0
76	light brown walnut <input type="checkbox"/> A	+\$0
HX	aged cherry <input type="checkbox"/> A	+\$0
HY	walnut on cherry <input type="checkbox"/> A	+\$0

Wood Veneer

For veneer (W)

2U	light brown walnut <input type="checkbox"/> A	+\$0
40	dark brown walnut <input type="checkbox"/> A	+\$0
ED	aged cherry <input type="checkbox"/> A	+\$0
EK	medium red walnut <input type="checkbox"/> A	+\$0
ET	clear on ash <input type="checkbox"/> A	+\$0
EU	oak on ash <input type="checkbox"/> A	+\$0
EV	walnut on ash <input type="checkbox"/> A	+\$0
UL	natural maple <input type="checkbox"/> A	+\$0
UX	walnut on cherry <input type="checkbox"/> A	+\$0

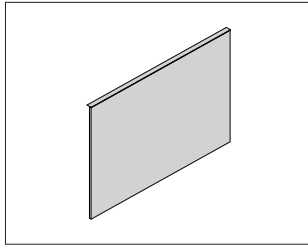

Product Information

Description

This tackable fabric or marker board insert attaches to the backside of a team wall, technology module (FC100) or hangs from the back of shelves on the display wall (FC110). It creates a 6" opening between top of infill and top of the wall, and a 5" opening at the mid level of the wall.

Notes

To accept infill, team wall technology module (FC110) shelf orientation must have all shelves facing forward or top and bottom shelves facing forward and middle shelf facing back.

Team wall infill accepts Customers Own Material (COM). Yardage is estimated for directional, 54"-wide fabrics.

For tackable fabric option (T)

Width—Yardage

All widths—1.10

For tackable fabric, horizontal (R)

Width—Yardage

All widths—1.53

For information on multiple quantities or nondirectional fabrics, contact COM department. See Order Information in Appendices.

Dimensions

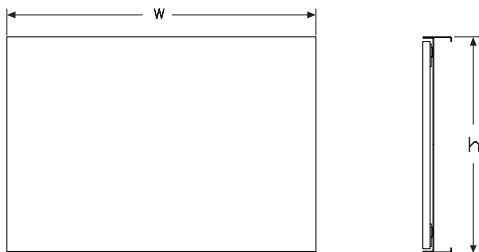

Specification Information

Step 1.

FC111. [A](#)

Step 2. Height

33 33" high [A](#)

Step 3. Width

42 42" wide [A](#)

48 48" wide [A](#)

Step 4. Surface Material

T tackable fabric [A](#)

R tackable fabric, horizontal [A](#)

M marker board [A](#)

Prices for Steps 1-4.

		T	R	M
FC111.	33 42	\$679	700	864
	48	\$723	744	909

Step 5. Back Finish

Bright Sand Texture Paint

91	white A	+\$0
CL	cool grey neutral A	+\$0
G1	graphite A	+\$0
WN	warm grey neutral A	+\$0
8Q	folkstone grey A	+\$0
98	studio white A	+\$0
WL	sandstone A	+\$0

Metallic Paint

CN	metallic champagne A	+\$0
EH	metallic bronze A	+\$0
MS	metallic silver A	+\$0

Step 6. Fabric

For tackable fabric (T) or tackable fabric, horizontal (R)

Price Category 1	+\$0
Price Category 2	+\$20
Price Category 3	+\$34
Price Category 4	+\$54
Price Category 5	+\$111
Price Category B	+\$56
Price Category C	+\$79
Price Category D	+\$100
Price Category E	+\$121
Price Category F	+\$157
Price Category G	+\$204

Peninsula, Display Wall
Technology Module

FCS60.
FCT60.

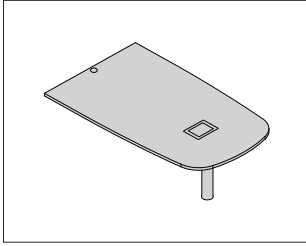

Product Information

Description

This peninsula attaches to the team wall technology module (FC100). It is available in a laminate top with thermoplastic edge and veneer top with veneer edge. Technology well provides access to power and data and contains a urethane edge.

Notes

Column finish includes technology bin and power/data access door finish. For solid color laminates, surface door and urethane edge matches the laminate. For veneer or wood grain laminate, door and urethane edge is specified.

Actual width of peninsula is 78", extending 60" from tech display wall.

46" deep peninsula is used with 48" wide tech display wall.

Wire grommets and power/data receptacles are available in black only.

Dimensions

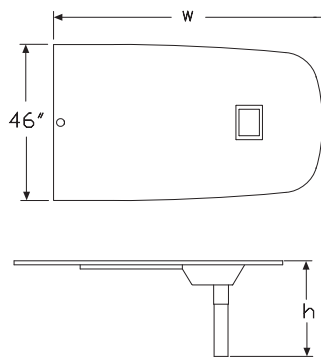

Specification Information

Step 1.

FC A

Step 2. Edge Type

T60. thin-edge A

S60. squared-edge A

Step 3. Depth

46 46" deep A

Step 4. Width

60 60" wide A

Step 5. Position

S seated height A

T standing height A

Step 6. Power/Data Access

P powered A

A modular power cord w/ plug end A

Step 7. Surface Material

L laminate top/thermoplastic edge A

W veneer top/veneer edge A

Prices for Steps 1-7.

	SPL	SPW	SAL	SAW	TPL	TPW
FCT60. 46 60	\$4833	6273	4833	6273	5357	6798

	TAL	TAW
FCT60. 46 60	\$5357	6798

	SPL	SPW	SAL	SAW	TPL	TPW
FCS60. 46 60	\$4026	5227	4026	5227	4463	5665

	TAL	TAW
FCS60. 46 60	\$4463	5665

Peninsula, Display Wall Technology Module *continued*

Step 8. Top/Edge Finish

Solid-Color Laminate

For laminate top/thermoplastic edge (L)

8Q	folkstone grey A	+\$0
91	white A	+\$0
98	studio white	+\$0
CL	cool grey neutral A	+\$0
LU	soft white A	+\$0
WL	sandstone A	+\$0
WN	warm grey neutral A	+\$0

Linen Laminate

For laminate top/thermoplastic edge (L)

LBM	crisp linen	+\$0
LBN	classic linen	+\$0
LBP	casual linen	+\$0

Mesh Laminate

For laminate top/thermoplastic edge (L)

LBK	pewter mesh	+\$0
LBL	steel mesh	+\$0

Twill Laminate

For laminate top/thermoplastic edge (L)

LBF	neutral twill	+\$0
LBG	sarum twill	+\$0
LBH	earthen twill	+\$0
LBJ	graphite twill	+\$0
LBQ	white twill	+\$0

Wood-Grain Laminate

For laminate top/thermoplastic edge (L)

HM	natural maple A	+\$0
HP	light anigre A	+\$0
LBA	clear on ash	+\$0
LBB	oak on ash	+\$0
LBC	walnut on ash	+\$0
LBD	dark brown walnut	+\$0
LBE	medium red walnut	+\$0
76	light brown walnut A	+\$60
HX	aged cherry A	+\$60
HY	walnut on cherry A	+\$60

Wood Veneer

For veneer top/veneer edge (W)

2U	light brown walnut A	+\$125
40	dark brown walnut A	+\$125
ED	aged cherry A	+\$125
EK	medium red walnut A	+\$125
ET	clear on ash A	+\$125
EU	oak on ash A	+\$125
EV	walnut on ash A	+\$125
UL	natural maple A	+\$125
UX	walnut on cherry A	+\$125

Step 9. Tech Lid Finish

91	white A	+\$0
LU	soft white A	+\$0
WL	sandstone A	+\$0
WN	warm grey neutral A	+\$0
8Q	folkstone grey A	+\$0
CL	cool grey neutral A	+\$0
G2	graphite satin A	+\$0

Step 10. Column/Bin Finish

Bright Sand Texture Paint

91	white A	+\$0
CL	cool grey neutral A	+\$0
G1	graphite A	+\$0
WN	warm grey neutral A	+\$0
8Q	folkstone grey A	+\$0
98	studio white A	+\$0
WL	sandstone A	+\$0

Metallic Paint

CN	metallic champagne A	+\$0
EH	metallic bronze A	+\$0
MS	metallic silver A	+\$0

Standing Screen

FC300.

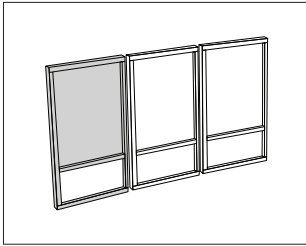

Product Information

Description

This screen is 68" high by 36" or 48" wide. It provides boundary and space division within an open plan environment. It is available with tackable fabric, and marker board infills, as well as marker board/tackable fabric or acrylic glaze infills.

Notes

The screen has an exposed plywood edge. Laminate screens have a clear finish on the exposed edge. Veneer screens have a stained finish to match the frame finish on the exposed edge.

Open screen can accept 1/4"-thick material.

Fabric-covered tile accepts Customers Own Material (COM). Yardage is estimated for directional, 54"-wide fabrics.

For tackable fabric option (T)

Width—Yardage

All widths—2.90

For tackable fabric, horizontal option (R)

Width—Yardage

36"—2.16

48"—2.87

For information on multiple quantities or nondirectional fabrics, contact COM department. See Order Information in Appendices.

Dimensions



Specification Information

Step 1.

FC300. A

Step 2. Height

68 68" high A

Step 3. Width

36 36" wide A

48 48" wide A

Step 4. Frame Material

L laminate A

W veneer A

Step 5. Infill Material

T tackable fabric, infill A

R tackable fabric, horizontal infill A

M marker board infill A

D tackable fabric/marker board infill A

Z tackable fabric, horizontal/marker board infill A

N no infill A

J9 acrylic glaze A

S woven screen A

Prices for Steps 1-5.

		LT	LR	LM	LD	LZ	LN
FC300. 68	36	\$2591	2670	2375	2375	2447	1820
	48	\$2755	2837	2526	2526	2600	1935
		LJ9	LS	WT	WR	WM	WD
FC300. 68	36	\$2375	2591	2799	2883	2567	2567
	48	\$2526	2755	2975	3064	2726	2726
		WZ	WN	WJ9	WS		
FC300. 68	36	\$2643	1966	2567	2799		
	48	\$2808	2090	2726	2975		

Step 6. Frame Finish

Solid-Color Laminate

For laminate (L)

8Q	folkstone grey <input type="checkbox"/>	+\$0
91	white <input type="checkbox"/>	+\$0
98	studio white	+\$0
CL	cool grey neutral <input type="checkbox"/>	+\$0
LU	soft white <input type="checkbox"/>	+\$0
WL	sandstone <input type="checkbox"/>	+\$0
WN	warm grey neutral <input type="checkbox"/>	+\$0

Linen Laminate

For laminate (L)

LBM	crisp linen	+\$0
LBN	classic linen	+\$0
LBP	casual linen	+\$0

Mesh Laminate

For laminate (L)

LBK	pewter mesh	+\$0
LBL	steel mesh	+\$0

Twill Laminate

For laminate (L)

LBF	neutral twill	+\$0
LBG	sarum twill	+\$0
LBH	earthen twill	+\$0
LBJ	graphite twill	+\$0
LBQ	white twill	+\$0

Wood-Grain Laminate

For laminate (L)

HM	natural maple <input type="checkbox"/>	+\$0
HP	light anigre <input type="checkbox"/>	+\$0
LBA	clear on ash	+\$0
LBB	oak on ash	+\$0
LBC	walnut on ash	+\$0
LBD	dark brown walnut	+\$0
LBE	medium red walnut	+\$0
76	light brown walnut <input type="checkbox"/>	+\$0
HX	aged cherry <input type="checkbox"/>	+\$0
HY	walnut on cherry <input type="checkbox"/>	+\$0

Wood Veneer

For veneer (W)

2U	light brown walnut <input type="checkbox"/>	+\$0
40	dark brown walnut <input type="checkbox"/>	+\$0
ED	aged cherry <input type="checkbox"/>	+\$0
EK	medium red walnut <input type="checkbox"/>	+\$0
ET	clear on ash <input type="checkbox"/>	+\$0
EU	oak on ash <input type="checkbox"/>	+\$0
EV	walnut on ash <input type="checkbox"/>	+\$0
UL	natural maple <input type="checkbox"/>	+\$0
UX	walnut on cherry <input type="checkbox"/>	+\$0

Step 7. Infill Finish

For tackable fabric, infill (T), tackable fabric, horizontal infill (R), tackable fabric/marker board infill (D), or tackable fabric, horizontal/marker board infill (Z)

Price Category 1	+\$0
Price Category 2	+\$33
Price Category 3	+\$53
Price Category 4	+\$88
Price Category 5	+\$184
Price Category B	+\$92
Price Category C	+\$139
Price Category D	+\$184
Price Category E	+\$229
Price Category F	+\$337

For woven screen (S)

Price Category 1	+\$0
------------------	------

Standing Screen Support

FC310.

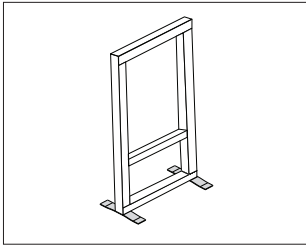

Product Information

Description

This foot attaches to and provides support for the standing screen (FC300). The single support foot (1) option is used for screen runs which contain a 90° or 120° connection kit and contains one small foot and attachment hardware. The in-line screen foot (2) option is used for screen runs which contain an in-line (180°) connection kit and contains one large foot and attachment hardware. The single screen foot kit (3) option is used for single screen applications and contains 2 feet and a bottom rail ballast.

Dimensions

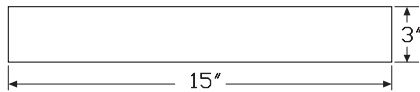

Specification Information

Step 1.

FC310. A

Step 2. Type

- 1** single support foot A
- 2** in-line screen foot A
- 3** single screen foot kit A

Prices for Steps 1-2.

FC310. 1	\$104
2	\$176
3	\$493

Step 3. Finish

Bright Sand Texture Paint

G1 graphite A	+ \$0
--	-------

Standing Screen Connector Kit FC311.

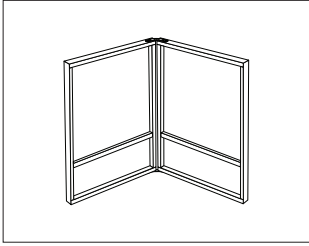

Canvas Office Landscape® Standing Screens

Product Information

Description

These connector kits join together standing screens (FC300) in 90°, 120°, and 180° configurations.

Notes

End-of-run kit includes 4 pieces.
Creates a 1/2" gap at all connections.

Dimensions



Frame End Cap



In Line or 180°

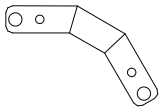

120°

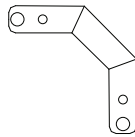

90°

Specification Information

Step 1.

FC311. [A](#)

Step 2. Configuration

- 1** 90° connection [A](#)
- 2** 120° connection [A](#)
- 3** 180° connection [A](#)
- 4** end-of-run [A](#)

Prices for Steps 1-2.

FC311. 1	\$131
2	\$131
3	\$131
4	\$131

Step 3. Finish

Bright Sand Texture Paint

G1 graphite A	+ \$0
--------------------------------------	-------

Index by Product Name

Canvas Office Landscape® Group	
Peninsula, Display Wall Technology Module	page(s) 13
Standing Screen	15
Standing Screen Connector Kit	18
Standing Screen Support	17
Team Wall	8
Team Wall Infill	11
Team Wall, Technology Module	5



Index by Product Number

FC100. Team Wall, Technology Module	page(s) 5
FC110. Team Wall	8
FC111. Team Wall Infill	11
FC300. Standing Screen	15
FC310. Standing Screen Support	17
FC311. Standing Screen Connector Kit	18
FCS60. Peninsula, Display Wall Technology Module	13
FCT60.	



20-Day or Less/Assigned Lead-Time Order Information

20-Day or Less and Assigned Lead-Time Programs

20-day or less and assigned lead-time products are designed for established Herman Miller dealers with pre-approved credit.

Products are distributed from multiple manufacturing facilities across the United States. All products and options not designated by an Assigned Lead-Time icon **A** will ship in 20 business days or less after being acknowledged by Herman Miller. Products and options designated by an **A** are on the assigned lead-time program and will ship in 20 days, less than 20 days, or more than 20 days from order acknowledgement.

Ordering Procedure

Please place orders through Order Manager. If this is not available to you, place orders through mail or fax. Verbal purchase orders will not be accepted.

Order Entry fax number for Passage®, 5000 Series, and Meridian® Filing and Storage: (616) 846 9236.

Order Entry fax number for all other products:
(616) 654 3085.

For more information, contact your Customer Care representative at:
(866) 854 3048 EXT 3400.

Shipments and Delivery

Per Herman Miller Terms and Conditions.

Changes and Cancellation

Per Herman Miller Terms and Conditions.



Vary Easy Program

Program Overview

Vary Easy is a program designed to help dealers specify standard products with a larger breadth of options. For example, depending on the type of product being specified, choices include additional size, finish, edge types, and cable management features. Vary Easy 3D, specIT, and third-party text-based specification packages support the Vary Easy program. Vary Easy 3D enables designers to create a 3D image, CAD symbols, and a price book page. A Vary Easy product number is assigned for each product as the user selects specific options. Once the product is completely specified, the order can be submitted via Kiosk's Order Manager or a dealer's business system.

Accessing and Specifying Vary Easy

To view the full product vocabulary, go to the Vary Easy Product Offering on Kiosk. To specify Vary Easy, go to the Vary Easy 3D website on Kiosk, specIT, or your third-party text-based specification package.

Once you've made your product line selection, continue to follow through each option and enter the specific options that represent the product you need. When the product is fully specified, Vary Easy will generate an orderable product number and instantly calculate a price.

Note: Failure to completely specify a product will cause a delay in order acknowledgements. Be sure to make a selection for all options offered.

The acknowledgement process for Vary Easy products is the same as for any standard order. Vary Easy products ship with a standardized lead time and are competitively priced.

For more information, contact your Customer Care Line at (866) 854 3048 EXT 3400.



Fire Retardancy for Proprietary Fabrics

Action Office® Products

The panel types listed below, when covered with the textiles identified below, meet the Class A requirements for flame spread and smoke development as specified by the National Fire Protection Association (NFPA) in the 2015 Life Safety Code No. 101, and the Underwriter's Laboratories requirements for use with energy distribution components (listed by UL under Office Furnishings 1286).

Panel Type	
fabric covered	stacking fabric covered
acoustical	tackable acoustical barrier partial-glazed

Textiles			
Bento	Gem ¹	Loom	Slant
Chain	Glaze	Medley	Stitches
Code	Glisten	Pins and Needles	Strands
Connection	Grasscloth	Quilty	String Plaid
Cord	Grosgrain ¹	Resonance	Tailored
Crepe	Ground Cloth®	Rivet	Twist ¹
Crossing	Hopsak	Savannah	
Current	Horizon	Silkworm	
Frost	Kira 2	Sironetta	

¹ Fabric not available on acoustical panels.

Action Office Products

The panel type listed below meets the Class A requirements for flame spread and smoke development as specified by the National Fire Protection Association (NFPA) in the 2015 Life Safety Code No. 101, and the Underwriter's Laboratories requirements for use with energy distribution components (listed by UL under Office Furnishings 1286).

Panel Type
hard-surfaced

Ethospace® Products

Acoustical tiles, when covered with the textiles identified below, meet the Class B requirements for flame spread and smoke development as specified by the NFPA in the 2015 Life Safety Code No. 101, and the Underwriter's Laboratories requirements for use with electrical components (listed by UL under Office Furnishings 1286).

Face tiles and beltline communication tiles, when covered with the textiles identified below, meet the Class A requirements for flame spread and smoke development as specified by the National Fire Protection Association (NFPA) in the 2015 Life Safety Code No. 101, and the Underwriter's Laboratories requirements for use with electrical components (listed by UL under Office Furnishings 1286).

Tackable tiles, when covered with the textiles identified below, meet the Class B requirements for flame spread and smoke development as specified by the NFPA in the 2015 Life Safety Code No. 101, and the Underwriter's Laboratories requirements for use with electrical components (listed by UL under Office Furnishings 1286).

Tile Type	
face tile	beltline face tile
tackable tile	cable access tile
acoustical tile	cable channel tile

Textiles			
Chain	Gem	Loft	Silkworm
Code	Glaze	Loom	Sironetta
Connection	Glisten	Medley	Slant
Cord	Grasscloth	Moiré	Strands
Crepe	Grosgrain	Pins and Needles	String Plaid
Crossing	Ground Cloth®	Quilty	Tailored
Current	Hopsak	Resonance	Twist
Fish Net	Horizon	Rivet	Well Suited
Frost	Kira 2	Savannah	

Fire Retardancy — Workspaces

continued

Canvas Office Landscape® Products

Tiles, when covered with the textiles identified below, meet the Class A requirements for flame spread and smoke development as specified by the National Fire Protection Association (NFPA) in the 2015 Life Safety Code No. 101, and the Underwriter's Laboratories requirements for use with electrical components (listed by UL under Office Furnishings 1286).

Tile Type

lower tile	lower power/data tile
full height tile	off-module upper tile
upper tile	upper power/data tile

Textiles

Bento	Gem	Loom	Slant
Chain	Glaze	Medley	Stitches
Code	Glisten	Moiré	Strands
Connection	Grasscloth	Pins and Needles	String Plaid
Cord	Grosgrain	Quilty	Tailored
Crepe	Ground Cloth	Resonance	Tape
Crossing	Hopsak	Rivet	Twist
Current	Horizon	Savannah ¹	Well Suited
Fish Net	Kira 2 ¹	Silkworm	
Frost	Loft ¹	Sironetta	

¹ Canvas tiles, when covered in Kira 2, Loft, or Savannah meet the Class B requirements for flame spread and smoke development as specified by the NFPA in the 2015 Life Safety Code No. 101.

Fire Retardancy for Maharam® Fabrics

The panel types, tile types, and textiles listed below are recognized by the Underwriters Laboratories under the UL Component Recognition Program. The following UL recognized fabrics, when used on the panel or tile types listed below, fall within a Class C requirement for flame spread and smoke development as specified by the National Fire Protection Association (NFPA) in the 2015 Life Safety Code No. 101. The panels and tiles are incomplete in construction features when tested. The UL Component Recognition Program does not provide evidence of UL listing or labeling, which may be required by installation codes or standards.

Tackable tiles, when covered with the textiles identified below, meet a minimum Class C requirement for flame spread and smoke development as specified by the NFPA in the 2015 Life Safety Code No. 101, and the Underwriters Laboratories requirements for use with electrical components (listed by UL under Office Furnishings 1286).

Action Office Products	
Panel Type	
fabric covered	stacking fabric covered
acoustical	tackable acoustical barrier partial-glazed

Textiles	
Adjourn	Parallel ¹
Crisp ²	Plait
Glance	Reply
Glint	Sharkskin 2
Hum	Skein
Manner	Sketch
Metric	Spiral
Mode	Ticker
Morse	Unit

¹ Fabric not available on acoustical panels.

² Fabric not available on partial-glazed panels.

Ethospace Products	
Tile Type	
face tile	beltline face tile
tackable tile	cable access tile
acoustical tile	cable channel tile

Textiles	
Adjourn	Parallel
Crisp ¹	Plait
Glance	Sharkskin 2
Glint	Skein
Hum	Sketch
Manner	Spiral
Messenger	Ticker
Morse	

¹ Fabric not available on tackable tiles.

Canvas Office Landscape Products		
Tile Type		
lower tile		lower power/data tile
full height tile		off-module upper tile
upper tile		upper power/data tile

Textiles	
Crisp	Plait
Hum	Reply
Manner	Sharkskin 2
Medium	Skein
Messenger	Sketch
Metric	Spiral
Morse	Ticker
Parallel	Unit

Stain-to-Match Program

Stain-to-Match Program

Program Overview

The Stain-to-Match program gives you the option of using veneer finishes that are not listed in the standard offering. The program allows Herman Miller to match a customer's existing recut or natural veneer, or create a new finish that is unique to an installation.

Specific information on approval, ordering, pricing, and warranty for the Stain-to-Match program is listed below. Questions and requests for assistance may be directed to Herman Miller Options at:

(800) 654 3910

Stain-to-Match Process

1. Fill out the Options Stain-to-Match Request Form and send along with a color sample (2" x 3" minimum) to the Herman Miller Options Applications Team at the address provided on the form. The form can be found on Omni.
2. Within 7-10 working days, Herman Miller Options will send a sample of the color-matched stain on Herman Miller veneer to the requester for the customer's signed approval.
3. If the sample meets the customer's approval, sign the reverse side of the sample, scan and email the approval to:
options@hermanmiller.com.
4. After the stain has been approved, a formal quotation with special number and pricing can be provided, or the product can be specified through the Vary Easy program, if available. Work with the Options team on final product needs and how to specify.
5. A purchase order can then be placed.

Stain-to-Match Warranty

Herman Miller warrants its products to be free from defects in craftsmanship from the date of delivery for the applicable warranty period. Herman Miller is responsible for the physical properties of the veneers available through the Stain-to-Match program, which include:

- STA: Stain-to-Match on Recut Ash
- STB: Stain-to-Match on Beech
- STC: Stain-to-Match on Cherry
- STD: Stain-to-Match on Oak
- STK: Stain-to-Match on Reltech Anigre (Geiger)
- STM: Stain-to-Match on Recut Mahogany
- STP: Stain-to-Match on Maple
- STU: Stain-to-Match on Walnut (Geiger)

See your specification tool for product specific finish offering limitations.



Canvas Office Landscape® Connectors and Covers Matrix

Use the following matrix to confirm your connector, cover, and top cap selection based on the frame heights specified. This matrix represents a subset of the possible frame and connector applications and shows the correct connector, connector cover, and top cap to specify.

For additional applications and information, see the Canvas Office Landscape® Planning Guide.

Legend

Frames

-  Same Height/Tallest
-  11" Drop in Height
-  22" Drop in Height

Connectors

35" and 46" High Frames



 .46

57", 68" and 79" High Frames

 .57

Covers

One Side

-  .1 + Required Height
-  (Shown When 2 are Required)

Two Sides

 .2 + Required Height

Three Sides

 .3 + Required Height

Top Caps

 .1A

 .2A

 .2B

 .3A

 .4A

2-Way, Equal-Height Frames

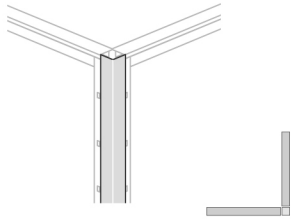

Frames 35/35



Frames 46/46



Frames 57/57



Frames 68/68



Frames 79/79



2-Way, 1 Frame 11" Lower

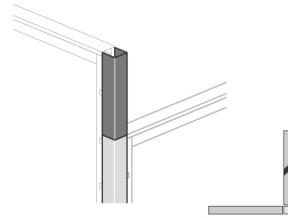

Frames 46/35

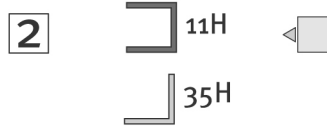

Frames 57/46

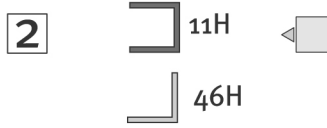

Frames 68/57

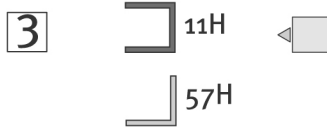

Frames 79/68

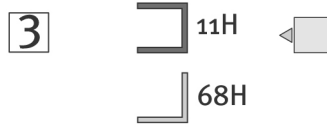

2-Way, 1 Frame 22" Lower

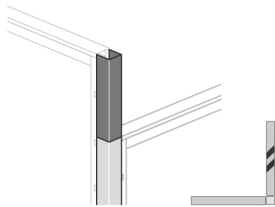

Frames 57/35

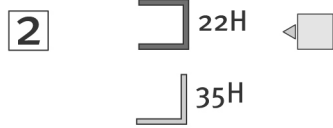

Frames 68/46

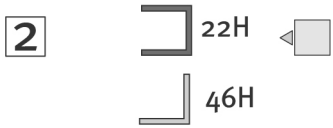

Frames 79/57

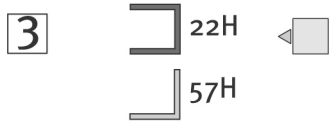

3-Way, Equal-Height Frames

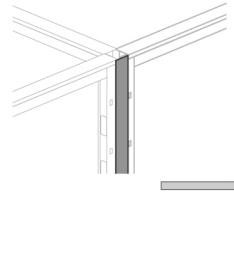

Frames 35/35/35

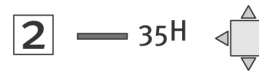

Frames 46/46/46

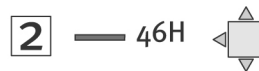

Frames 57/57/57

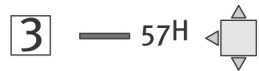

Frames 68/68/68

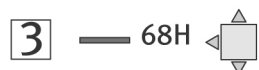

Frames 79/79/79

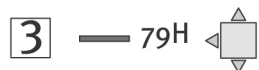

Canvas Office Landscape® Connectors and Covers Matrix *continued*

3-Way, 1 Frame 11" Higher

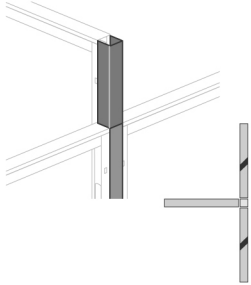

Frames 35/46/35

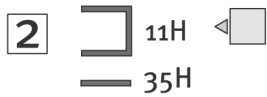

Frames 46/57/46

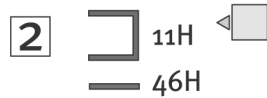

Frames 57/68/57

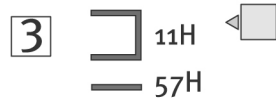

Frames 68/79/68



3-Way, 1 Frame 22" Higher

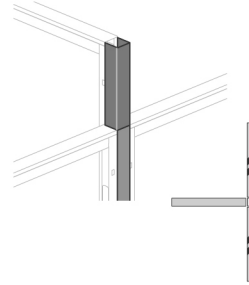

Frames 35/57/35

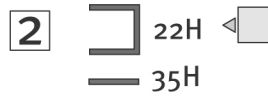

Frames 46/68/46



Frames 57/79/57

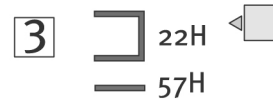

4-Way, Equal-Height Frames

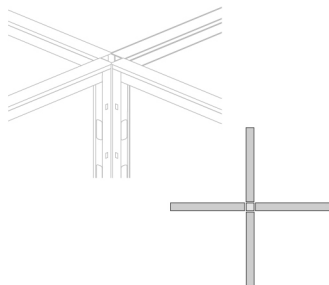

Frames 35

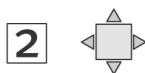

Frames 46



Frames 57

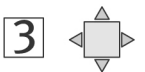

Frames 68

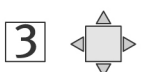

Frames 79

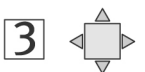

**4-Way, 2 180° Equal-Height Frames, 2 180° Frames
11" Lower**

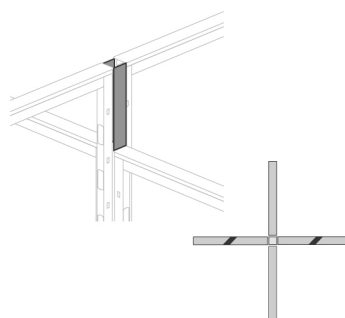

Frames 46/35/46/35

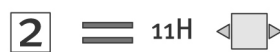

Frames 57/46/57/46

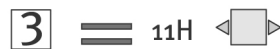

Frames 68/57/68/57

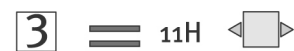

Frames 79/68/79/68

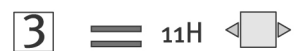

Canvas Office Landscape® Connectors and Covers Matrix *continued*

Appendix: Canvas Office Landscape® Connectors and Covers Matrix

4-Way, 2 180° Equal-Height Frames, 2 180° Frames 22" Lower

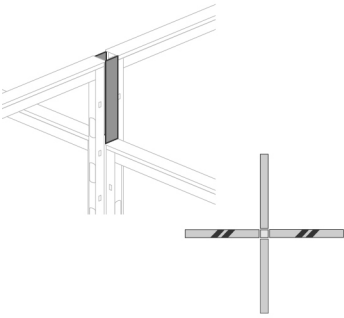

Frames 57/35/57/35

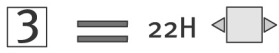

Frames 68/46/68/46

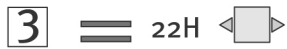

Frames 79/57/79/57

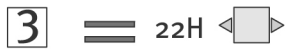

4-Way, 2 90° Frames 11" Lower, 1 Frame 22" Lower

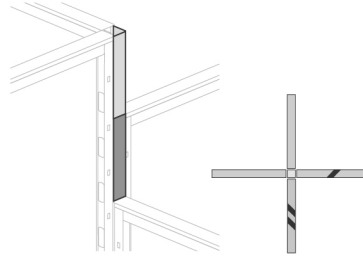

Frames 57/57/46/35

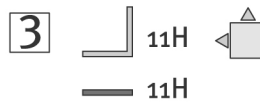

Frames 68/68/57/46

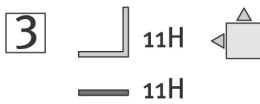

Frames 79/79/68/57

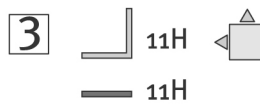

Customer's Own Material/ Customer's Own Leather Order Information — Cushion Tops

Customer's Own Material/Customer's Own Leather

Program Overview

The Customer's Own Material (COM) and Customer's Own Leather (COL) program gives you the option of using textiles other than those listed. Herman Miller will test textiles for application to Herman Miller products and will process orders for those with approved COM/COL textiles only. COM/COL are assigned lead time textiles.

Omni lists an overview of fabrics and leathers that have been tested and indicates whether or not they were approved for application to Herman Miller products.

Specific information on the terms and conditions, testing, approval, and ordering process for COM/COL is listed below. Questions about the COM/COL program and requests for assistance may be directed to your COM representative at:

(616) 654 3400

(866) 854 3048 EXT 6543400

Customer's Own Material/Customer's Own Leather Warranty

Herman Miller does not warrant COM/COL textiles. COM/COL textiles are tested for application only; they are not tested for performance. The Herman Miller warranty does apply to the underlying products.

Suppliers of COM/COL textiles are responsible for color consistency within commercial tolerances, UV stability, and resistance to soiling and perspiration.

Customer's Own Material/Customer's Own Leather Pricing

COM is a Category 1 fabric. There are no application charges for COM fabrics. COL is a Category 7 textile; refer to prices on specific products to determine the application charge.

Ordering and payment for COM/COL textile yardage are the responsibility of the customer and the textile supplier.

If desired, Herman Miller will purchase COM textiles directly from True Textiles, C.F. Stinson, Luna Textiles, Maharam, and Momentum Textiles to simplify ordering and shipment. For this service, refer to the Supplier Connection program.

Application Note

Herman Miller does not guarantee that Customer's Own Material (COM) fabric patterns will align across panels/tiles or from one screen to the next. We also do not guarantee that COM fabric designs will be positioned consistently in the same location across several panels, tiles, or screens.

Textile Approval

1. Select a COM/COL textile.
2. If your textile is not listed on Omni, obtain a test number from a COM representative at (616) 654 3400. You can also submit your request within Omni. Please have the following information ready before calling: textile name, number, pattern, and the product you will apply it to.
3. Herman Miller will notify you of approval or disapproval within 4 days from receipt of the test yardage.

Customer's Own Material/ Customer's Own Leather Order Information — Cushion Tops

continued

Ordering Products with COM/COL

1. Refer to the specific products to determine the yardage required for COM/COL textiles.
2. If your textile is not listed on Omni, call a COM representative at (616) 654 3400 or (866) 854 3048 EXT 6543400. The representative will assign an identification number for your textile (ID#) and will verify yardage requirements for your order. Yardage requirements are based on directional, 54"-wide textiles. Additional yardage may be needed due to the unique characteristics of a textile.
3. Enter your order on Order Manager in Omni.
4. Upon receipt of your purchase order, Herman Miller will send you a PO acknowledgment.
5. Arrangements must be made for the textiles to be shipped from the supplier to Herman Miller for application to the seating products. See Omni for shipping procedures and current shipping addresses or contact a COM representative at (616) 654 3400 or (866) 854 3048 EXT 6543400.

Products will be scheduled for production when COM/COL textiles are received at Herman Miller. Standard lead times in effect at that time will apply.

Note: If textiles are to be purchased directly by Herman Miller through the Supplier Connection program, Herman Miller will handle the ordering and shipping process and will schedule your order for production upon receipt of your purchase order (dependent on textile availability). Refer to the Supplier Connection program for more information.

Supplier Connection

Program Overview

The Supplier Connection program is a service offered by Herman Miller to purchase approved COM textiles directly from True Textiles, C.F. Stinson, Luna Textiles, Maharam, and Momentum Textiles. When you select a textile through this program, Herman Miller will facilitate the ordering, scheduling, and shipment of the textile directly with the supplier.

Suppliers included in the Supplier Connection program keep an active inventory of textiles that are pre-approved for application to Herman Miller products. Pre-approval applies only to the suitability of a textile for manufacturing and application to a Herman Miller product. Omni provides an overview of fabrics that have been tested and indicates whether or not they were approved for application to Herman Miller products.

Specific information on the terms and conditions, testing, approval, and ordering process for the Supplier Connection program is listed below. Questions and requests for assistance may be directed to your COM representative at:

(616) 654 3400
(866) 854 3048 EXT 6543400

Supplier Connection Warranty

Textiles purchased by Herman Miller through the Supplier Connection program are COM and are not warranted by Herman Miller. COM textiles are tested for application only; they are not tested for performance. The Herman Miller warranty does apply to the underlying products.

Suppliers of COM textiles are responsible for color consistency within commercial tolerances, UV stability, and resistance to soiling and perspiration.

Customer's Own Material/ Customer's Own Leather Order Information — Cushion Tops

continued

Supplier Connection Pricing

Textiles purchased by Herman Miller through the Supplier Connection program are COM. COM is a Category 1 fabric. There are no application charges for COM fabrics.

Payment for textiles purchased by Herman Miller through the Supplier Connection program is the responsibility of the customer or dealer. Herman Miller will invoice the order at the supplier's prices published at the time of the order.

Textile Approval

1. Refer to Omni to identify the approval status of the textile. If your textile is not listed, contact the COM Department to request testing for application to Herman Miller products.
2. Herman Miller will notify you of approval or disapproval in approximately 4 days from receipt of the test yardage. If the textile is approved, it will be assigned a COM identification number.

Ordering Products with Supplier Connection COM

1. Identify and include the following information on your purchase order:
 - Product number and option
 - Herman Miller's COM identification number
2. Enter your order on Order Manager in Omni.
3. Upon receipt of the purchase order, Herman Miller will process your order and send you a PO acknowledgment. Herman Miller will determine the yardage required to produce your product and will order and schedule for delivery the required textile. Standard lead times in effect at the time the textile is allocated at the supplier will apply to products ordered through this program.



Customer's Own Material Order Information — Workspaces

Customer's Own Material

Program Overview

The Customer's Own Material (COM) program gives you the option of using textiles other than those listed. Herman Miller will test textiles for application to Herman Miller products and will process orders for those with approved COM textiles only. COM textiles are on assigned lead times.

Omni lists an overview of fabrics that have been tested and indicates whether or not they were approved for application to Herman Miller products.

Specific information on the terms and conditions, testing, approval, and ordering process for COM is listed below. Questions about the COM program and requests for assistance may be directed to your COM representative at:

(616) 654 3400

(866) 854 3048 EXT 6543400

Customer's Own Material Warranty

Herman Miller does not warrant COM textiles. COM textiles are tested for application only; they are not tested for performance. The Herman Miller warranty does apply to the underlying products.

Suppliers of COM textiles are responsible for color consistency within commercial tolerances, UV stability, and resistance to soiling and perspiration.

Customer's Own Material Pricing

COM is a Category 1 fabric. There are no application charges for COM fabrics.

Ordering and payment for COM textile yardage are the responsibility of the customer and the textile supplier.

If desired, Herman Miller will purchase COM textiles directly from True Textiles, C.F. Stinson, Luna Textiles, Maharam, and Momentum Textiles to simplify ordering and shipment. For this service, refer to the Supplier Connection program.

Application Note

Herman Miller does not guarantee that Customer's Own Material (COM) fabric patterns will align across panels/tiles or from one screen to the next. We also do not guarantee that COM fabric designs will be positioned consistently in the same location across several panels, tiles, or screens.

Textile Approval

1. Select a COM textile and a Herman Miller product.
2. If your textile is not listed in Omni, obtain a test number from a COM representative at (616) 654 3400. You can also submit your request within Omni. Please have the following information ready before calling: textile name, number, pattern, and the product you will apply it to.
3. Herman Miller will notify you of approval or disapproval within 4 days from receipt of the test yardage.

Ordering Products with COM

1. Refer to the specific products to determine the yardage required for COM textiles.
2. If your textile is not listed in Omni, call a COM representative at (616) 654 3400 or (866) 854 3048 EXT 6543400. The representative will assign an identification number for your textile (ID#) and will verify yardage requirements for your order.

Note: Yardage requirements are based on nondirectional, 54"-wide textiles. 66"-wide textiles are needed for application on 60"-wide products. Additional yardage may be needed due to the unique characteristics of a textile.

3. Enter your order on Order Manager in Omni.
4. Upon receipt of your purchase order, Herman Miller will send you a PO acknowledgment.
5. Arrangements must be made for the textiles to be shipped from the supplier to Herman Miller for application to the Herman Miller products. Textiles must be tagged with the assigned identification number and the roll yardage quantity. See Omni for shipping procedures and current shipping addresses or contact a COM representative at (616) 654 3400 or (866) 854 3048 EXT 6543400.

Products will be scheduled for production when COM textiles are received at Herman Miller. Standard lead times in effect at that time will apply.

Note: If textiles are to be purchased directly by Herman Miller through the Supplier Connection program, Herman Miller will handle the ordering and shipping process and will schedule your order for production upon receipt of your purchase order (dependent on textile availability). Refer to the Supplier Connection program for more information.

Customer's Own Material Order Information — Workspaces

continued

Supplier Connection

Program Overview

The Supplier Connection program is a service offered by Herman Miller to purchase approved COM textiles directly from True Textiles, C.F. Stinson, Luna Textiles, Maharam, and Momentum Textiles. When you select a textile through this program, Herman Miller will facilitate the ordering, scheduling, and shipment of the textile directly with the supplier.

Suppliers included in the Supplier Connection program keep an active inventory of textiles that are pre-approved for application to Herman Miller products. Pre-approval applies only to the suitability of a textile for manufacturing and application to a Herman Miller product. Omni provides an overview of fabrics that have been tested and indicates whether or not they were approved for application to Herman Miller products.

Specific information on the terms and conditions, testing, approval, and ordering process for the Supplier Connection program is listed below. Questions and requests for assistance may be directed to your COM representative at:

(616) 654 3400

(866) 854 3048 EXT 6543400

Supplier Connection Warranty

Textiles purchased by Herman Miller through the Supplier Connection program are COM and are not warranted by Herman Miller. COM textiles are tested for application only; they are not tested for performance. The Herman Miller warranty does apply to the underlying products.

Suppliers of COM textiles are responsible for color consistency within commercial tolerances, UV stability, and resistance to soiling and perspiration.

Supplier Connection Pricing

Textiles purchased by Herman Miller through the Supplier Connection program are COM. COM is a Category 1 fabric. There are no application charges for COM fabrics.

Payment for textiles purchased by Herman Miller through the Supplier Connection program is the responsibility of the customer or dealer. Herman Miller will invoice the order at the supplier's prices published at the time of the order.

Textile Approval

1. Refer to Omni to identify the approval status of the textile. If your textile is not listed, contact the COM Department to request testing for application to Herman Miller products.
2. Herman Miller will notify you of approval or disapproval in approximately 4 days from receipt of the test yardage. If the textile is approved, it will be assigned a COM identification number.

Ordering Products with Supplier Connection COM

1. Identify and include the following information on your purchase order:
 - Product number and option
 - Herman Miller's COM identification number
2. Enter your order on Order Manager in Omni.
3. Upon receipt of the purchase order, Herman Miller will process your order and send you a PO acknowledgment. Herman Miller will determine the yardage required to produce your product and will order and schedule for delivery the required textile. Standard lead times in effect at the time the textile is allocated at the supplier will apply to products ordered through this program.

Proprietary Textiles Application Chart – Workspaces

• Available

[A] Assigned lead-time textile.

See page 3 for exception notes.

	Action Office® Panels/Connectors	Action Office/Ethospace® B-Style Storage	Action Office B-Style Tackboards	Action Office/Ethospace E-Style Storage	Ethospace Tiles/Connectors	Ethospace Work Surface-Attached Screens	Ethospace/Canvas Office Landscape® Privacy Doors	Canvas Tiles/Extended Width Tiles	Canvas B-/E-Style Storage	Canvas Standing Screen and Team Wall Infill	Canvas Signature Screen	Canvas Tackboards	Layout Studio® Framed Screen	Locale® Display Tackboard	Locale Freestanding Screen and Workbase Screen	Locale L-Desk/D-Desk Screens	Pari™ Screens	Prospect™ Exterior Acoustic Pad	Public Office Landscape® Screen/Desk Top Divider	Renew™ Link Screens	Resolve® Boundary Screens/Flags	Resolve Display Screens	Resolve Rolling Screens/Canopies	Exclave® Tackable Boards and Stowage Tackable Backdrop	Exclave Video-Friendly Tackable Boards and Stowage Tackable Backdrop	Intersect® Screens	Thrive® Personal Side Screen	Tu® Wood Storage Cubby Tackboard	5000 Series Storage and Tackboards	Seating		
Price Category 1																																
COM Customer's Own Material [A]	1	1	1	1	1		1	1	1	1		•	1	1	1		1		1	1	1						1	1		3	1	
8A__ Bubbletack™																						•										
2V__ Chain	•	•	•	•	•		•	22	•			•	•	•	•		•		•	•									•	3		
8T__ Crossing (85__)	2	2	2	•	•		•	•	2			•	•	•	•		•		•	•				•	8		•	•	•	3	18	
95__ Gem	2	2	2	•	•		•	•	2			•	•	•														•	•	•	3	•
2I__ Grasscloth	•	•	•	•	•		•	•	•	•		•		•	•	•		•		•	•						•	•	•	3		
1MN__ Monologue	2	2	2	•	•		•	•	2			•	•	•	•		•		•	•							•	•	•		•	
8B__ Multiscrim™						•															•		•									
5T__ Resonance	•	•	•	•	•		•	•	•	•		•	•	•													•	•	•			
8C__ Scrim Trim																							•									
22W__ Shade																																
2M__ Silkworm	•	•	•	•	•		•	•	•	•		•	•	•													•	•	•	3		
22F__ Slant	6		•	•	•							•	•	•													•	•	•	3		
235__ Tailored [A]	•	•		•	•		•	•	•	•		•	•	•													•	•	•		•	
1WS__ Whisper	2	2	2	•	•		•	•	2	•		•	•	•	•		•		•	•						•	•	•		•		
Price Category 2																																
1CD__ Code	•	•	•	•	•		•	•	•	•		•	•	•										•		•						
3P__ ColorGuard		2		•																												
51__ Cord	•	•	•	•	•		•	•	•	•		•	•	•													•	•	•	3		
92__ Crepe	2	•	•	•	•		•	•	•	•		•	•	•									•	8		•	•	•	3	•		
22Q__ Fish Net		2	2	•	•		•	•	2	•		•					•			•											•	
57__ Frost	•	•	•	•	•		•	•	•	•		•	•	•													•	•	•	3		
84__ Grosgrain	4	•	•	•	•		•	•	•	•			19														•	19	•	3		
4N__ Horizon	2	2	2	•	•		•	•	•	•		•	•	•													•	•	•	3		
1LM__ Loom	2	2	2	•	•		•	•	•	•		•	•	•																	•	
1HA__ Medley	2	2	2	•	•		•	•	•	•		•	•	•										•	8		•	•	•		•	
3A__ Moiré		2	2	•	•		•	22	2	•		•	•	•	•														•	3	•	
1RV__ Rivet	2	2	2	•	•		•	•	2	•		•		•	•		•		•	•							•	•	•		•	
43__ Tape							•	•	•	•		•		•																	•	
8R__ Twist (5S__)	5	2	2	•	•		•	•	2	•		•	•	•	•		•		•	•							•	•	•	3	18	
22T__ Well Suited		2		•	•		•	2	•																						•	
Price Category 3																																
70__ Bento	2	2	2	•			•	2	•		•	•	•	•													•	•	•	3	•	
1FB__ Connection	•	•	•	•	•		•	•	•	•		•	•	•													•	•	•	3		
1FC__ Current	•	•	•	•	•		•	•	•	•		•	•	•													•	•	•	3		
8Z__ Glaze	•	•	•	•	•		•	•	•	•		•	•	•													•	•	•	3		
47__ Ground Cloth®	•	•	•	•	•		•	•	•	•		•	•	•								14		•	8		•	•	•	3		
5D__ Kira 2	2	2	2	•	•		•	•	2	•		•	•	•													•	•	•	3		
22R__ Pins and Needles	2	2		•	•		•	•	2	•		•	•	•																	•	
8L__ Savannah	•	20	•	•	•		•	•	•	•		•	•	•								14									•	
8U__ Stitches (5Z__)	2	2	2	•			•	2	•		•	•	•														•	•	•	3	18	
8W__ Strands	•	•	•	•	•		•	•	•	•		•	•	•													•	•	•	3		
22V__ String Plaid	2	2	2	•	•		•	•	2	•		•	•	•													•	•	•		•	

continued on next page

Proprietary Textile Colors – Workspaces

Price Category 1

Customer's Own Material
See Order Information in
Appendices.
Assigned lead-time textile. A

Bubbletack™
100% polyester

8A01 Seashell White
8A02 Pearl Grey
8A05 Dune Beige
8A07 Pebble Beige
8A09 Olive Green
8A13 Slate Purple
8A19 Spa Blue
8A24 Sable Grey
8A27 Summer White
8A28 Moth Grey
8A29 Tea Leaf Grey
8A30 Blue Grey
8A31 Dusty Bronze
8A32 Slate Blue
8A33 Caramel Beige
8A34 Kiwi Green

Chain
66" wide
100% recycled polyester

2V01 Pearl
2V02 Oyster
2V03 Wheat
2V04 Linen
2V05 Wicker
2V06 Bamboo
2V07 Sage
2V08 Spring Wood
2V09 Iceberg

Crossing
54" wide
86% antimony-free polyester
14% polyester

8T03 Wicker *
8T04 Porcelain *
8T05 Warm Grey *
8T06 Sepia
8T07 Pumpkin
8T08 Copper
8T09 Cranberry
8T10 Tomato
8T11 Mulberry
8T12 Plum
8T13 Green Apple
8T14 Loden
8T15 Spruce
8T16 Periwinkle
8T17 Cerulean
8T18 Indigo
8T19 Shale *
8T20 Brownstone
8T21 Bark
8T22 Tin *
8T23 Graphite
8T24 Black

Crossing
For workspaces products only.
54" wide
86% antimony-free polyester
14% polyester

8501 Ivory *
8502 Oyster *

* Colors available on Exclave®
Video-friendly Tackable Boards
and Stowage Tackable Backdrop

Gem
54" wide
100% antimony-free polyester

9501 Sesame
9502 Tangerine
9503 Red
9504 Red Violet
9505 Mulberry
9506 Java
9507 Twilight
9508 Bayou
9509 Iris
9510 Berry Blue
9511 Aqua Green
9512 Green Apple
9513 Spruce
9514 Black
9515 Slate Grey
9516 Fog

Grasscloth
66" wide
100% recycled polyester

2I01 Silver Birch
2I02 Pampas
2I03 Sedge
2I07 Lea
2I08 Taro
2I09 Steam Grey
2I10 Cayenne
2I11 Bottle Green
2I12 Surf
2I13 Gravel

Monologue
54" wide
56% recycled polyester
44% polyester

1MN01 Linen
1MN02 Alabaster
1MN03 Truffle
1MN04 Folkstone
1MN05 Silver Pine
1MN06 Slate
1MN07 Seed
1MN08 Yellow Oxide
1MN09 Persimmon
1MN10 Tundra
1MN11 Meadow
1MN12 Blue Sky
1MN13 Blue Spruce
1MN14 Deep Sea

Multiscrim™
60" wide
100% polyester

8B01 Seashell White
8B02 Pearl Grey
8B05 Dune Beige
8B07 Pebble Beige
8B09 Olive Green
8B15 Slate Purple
8B19 Spa Blue
8B24 Sable Grey
8B27 Summer White
8B28 Moth Grey
8B29 Tea Leaf Grey
8B30 Blue Grey
8B31 Dusty Bronze
8B32 Slate Blue
8B33 Caramel Beige
8B34 Kiwi Green

Proprietary Textile Colors – Workspaces

continued

Price Category 1

continued

Resonance

66" wide
100% polyester
5T04 Greige
5T05 Porcelain
5T06 Alabaster
5T15 Iris
5T28 Sugar
5T47 Tobacco
5T54 Saltbush
5T57 Seed
5T58 Sepia
5T59 Tundra
5T60 Iceberg
5T61 Black
5T62 Chamois
5T63 Citrus
5T64 Tangerine
5T65 Red
5T66 Wild Berry
5T67 Boysenberry
5T68 Pistachio
5T69 Green Apple
5T70 Forest
5T71 Jade
5T72 Blue Green
5T73 Bright Turquoise
5T74 Twilight

Scrim Trim

61" wide
82% polyester
18% spandex
8C01 Seashell White
8C02 Pearl Grey
8C22 Winter Grey
8C24 Sable Grey

Shade

91% polypropylene
9% polyester
22W02 Tin
22W03 Graphite

Silkworm

66" wide
58% recycled polyester
42% polyester
2M01 Cocoon
2M02 Pongee
2M03 Saffron
2M04 Tussah
2M05 Ceylon
2M06 Jasmine
2M07 Shale
2M08 Monsoon

Slant

66" wide
51% polyester
49% recycled polyester
22F01 Beech Nut
22F02 Chamois
22F03 Chartreuse
22F04 Pesto
22F05 Peacock
22F06 Neptune
22F07 Blueberry
22F08 Boysenberry
22F09 Magenta
22F10 Pumpkin
22F11 Cranberry
22F12 Silver Birch
22F13 Bluestone
22F14 Truffle
22F15 Shale

Tailored

Assigned lead-time textile. ^A
54" wide
56% polyester
44% recycled polyester
23501 Studio White
23502 Sugar
23503 Tomato
23504 Orchid
23505 Boysenberry
23506 Chive
23507 Bluegrass
23508 Cobalt
23509 Cadet
23510 Fog
23511 Graphite
23512 Black
23513 Coffee

Whisper

54" wide
73% recycled polyester
27% polyester
1WS01 Sand Dollar
1WS02 Pebble
1WS03 Silver Birch
1WS04 Iceberg
1WS05 Silver Pine
1WS06 Carbon
1WS07 Cumin
1WS08 Adobe
1WS09 Strawberry
1WS10 Blush
1WS11 Eggplant
1WS12 Willow
1WS13 Sea Grass
1WS14 Pool
1WS15 Blueberry

Price Category 2

Code

66" wide
100% Repreve recycled polyester
1CD01 Linen
1CD02 Khaki
1CD03 Iceberg
1CD04 Zinc
1CD05 Blue Black

ColorGuard

54" wide
100% vinyl
3P01 Grey
3P02 Navy
3P03 Spruce ^A
3P04 Jade ^A
3P05 Natural ^A
3P08 Blueberry ^A
3P09 Coal ^A
3P12 Black Plum ^A
3P14 Black
3P15 New Burgundy ^A
3P17 Burgundy ^A
3P19 Slate
3P31 Horizon Blue ^A
3P33 Pumice
3P54 Candy Apple ^A
3P58 Beige ^A
3P66 Deep Clay ^A
3P72 Allspice ^A
3P90 Green Tea ^A
3P93 Camelback ^A
3P96 Manzanita ^A
3P97 Fudge ^A
3PB2 Sea Grass ^A
3PB5 Vizcaya Palm ^A
3PB9 Neptune ^A
3PC7 Bucksuede ^A
3PD4 Otter ^A

^A Assigned lead-time color.

Proprietary Textile Colors – Workspaces

continued

Price Category 2

continued

Cord

66" wide
51% antimony-free polyester
49% polyester
5101 Ivory
5102 White Ash
5103 Linen
5104 Bamboo
5105 Sepia
5106 Wicker
5107 Sesame
5108 Kiwi Green
5109 Bayou
5110 Shade
5111 Spring Wood
5112 Summer White

Crepe

54" wide
100% recycled polyester
9201 Licorice
9203 Smoke
9207 Cherry
9209 Claret
9212 Raisin
9218 Aquamarine
9223 Cadet
9241 Beachglass
9243 Midnight
9244 Artichoke
9248 Warm White *
9249 Stone *
9250 Earth
9251 Fog *
9252 Slate Grey
9253 Yellow Dark
9254 Coral
9255 Blush Grey *
9256 Wild Berry
9257 Clover
9258 Caribbean
9259 Cerulean
9260 Brownstone

* Colors available on Exclave®
Video-friendly Tackable Boards
and Stowage Tackable Backdrop

Crepe continued

9261 Shale
9262 Graphite
9263 Tomato
9264 Green Apple

Fish Net

55" wide
100% recycled polyester
22Q01 Oyster
22Q02 Stone
22Q03 Citrus
22Q04 Curry
22Q05 Chipotle
22Q06 Cherry
22Q07 Fuschia
22Q08 Claret
22Q09 Purple
22Q10 Clover
22Q11 Pesto
22Q12 Peacock
22Q13 Lagoon
22Q14 Twilight
22Q15 Bluestone
22Q16 Storm
22Q17 Black
22Q18 Cocoa

Frost

66" wide
100% recycled polyester
5701 Bisque
5702 Abalone
5703 Porcelain
5704 Honey
5705 Iceberg
5706 Sage
5707 Reed
5708 Steam Grey
5709 Gunmetal
5710 Sable Grey

Grosgrain

66" wide
100% recycled polyester
8401 Pearl *
8402 White Ash
8403 Warm Grey
8404 Khaki
8405 Oyster *
8406 Celadon
8408 Spa Blue
8409 Bud
8410 Kiwi Green
8411 Bayou
8412 Tin
8413 Iceberg *

* Colors not available on Canvas
Dock Mounted Screens, Locale®
Workbase Screen, Public Office
Landscape® Screen/Desk Top
Divider, and Thrive® Personal
Side Screen.

Horizon

54" wide
65% antimony-free polyester
35% polyester
4N01 Rye Grass
4N02 Sugar Pine
4N03 Silver Pine
4N04 White Ash
4N05 Spring Wood
4N06 Tamarack
4N07 Mushroom
4N08 Haystack
4N09 Oat Grass
4N10 Forest Moss
4N11 Hickory
4N12 Beech Nut
4N13 Pine Cone
4N14 Poplar
4N15 Elderberry

Loom

54" wide
100% polyester
1LM01 Linen
1LM02 Brown Sugar and Spice
1LM03 Brick and Mortar
1LM04 Salt and Pepper
1LM05 Black
1LM06 Lemongrass
1LM07 Poppy
1LM08 Wild Berry
1LM09 Loden
1LM10 Jade
1LM11 Deep Sea

Medley

54" wide
100% polyester
1HA01 Stone *
1HA02 Trail
1HA03 Charcoal
1HA04 Cinder
1HA05 Citrus
1HA06 Papaya
1HA07 Chutney
1HA08 Tundra
1HA09 Feather Grey *
1HA10 Chartreuse
1HA11 Loden
1HA12 Peacock
1HA13 Bayou *
1HA14 Blue Grotto
1HA15 Blueberry
1HA22 Khaki
1HA23 Pewter
1HA24 Yellow Oxide
1HA25 Vintage Rose
1HA26 Raspberry
1HA27 Acai Berry

* Colors available on Exclave®
Video-friendly Tackable Boards
and Stowage Tackable Backdrop

Proprietary Textile Colors – Workspaces

continued

Price Category 2

continued

Moiré

54" wide
100% recycled polyester
3A01 Concrete
3A02 Biscotti
3A03 Rattan
3A04 Chambray
3A05 Fern
3A08 Violet
3A09 Zin
3A10 Curry
3A11 Spice
3A12 Cork

Rivet

54" wide
100% recycled polyester
1RV01 Twig
1RV02 Deep Clay
1RV03 Woodrose
1RV04 Otter
1RV05 Hemlock
1RV06 Olive
1RV07 Lagoon
1RV08 Deep Sea
1RV09 Charcoal
1RV10 Grey Brindle

Tape

66" wide
52% polypropylene
48% recycled polyester
4301 Pearl
4302 Oyster
4303 Wicker
4304 Reed
4305 Straw
4306 Celadon
4307 Alabaster
4308 Bamboo
4309 Feather Grey
4310 Iceberg

Twist

54" wide
80% antimony-free polyester
13% recycled polyester
7% polyester
8R05 Wicker
8R10 Poppy
8R14 Tin
8R15 Shale
8R16 Graphite
8R17 Birch
8R18 Sepia
8R22 Blueberry
8R23 Green Apple
8R26 Gunmetal
8R27 Cinder
8R28 Citrus
8R29 Pekoe
8R30 Tangerine
8R31 Red Plum
8R32 Wisteria
8R33 Forest
8R34 Jade Dark
8R35 Waterfall
8R36 Midnight Blue
8R37 Carbon Dark

Twist

For workspaces products only.
54" wide
80% antimony-free polyester
13% recycled polyester
7% polyester
5S01 Pearl
5S02 Ivory
5S03 Oyster

Well Suited

55" wide
79% polyester
21% recycled polyester
22T01 Oyster
22T02 Raffia
22T03 Peppermint
22T04 Wild Berry
22T05 Spring Green
22T06 Mint
22T07 Periwinkle
22T08 Cool Grey
22T09 Citrus
22T10 Pumpkin
22T11 Red
22T12 Fuschia
22T13 Orchid
22T14 Chartreuse
22T15 Green Apple
22T16 Jade
22T17 Peacock
22T18 Blueberry
22T19 Bluestone
22T20 Mink

Price Category 3

Bento

54" wide
100% antimony-free polyester
7001 Frost
7002 Linen
7003 Khaki
7004 Truffle
7005 Grey Black
7006 Pumpkin
7007 Cranberry
7008 Everglade
7009 Cobalt

Connection

66" wide
100% antimony-free polyester
1FB1 Oyster
1FB2 Linen
1FB3 Iceberg
1FB4 Silver Pine
1FB5 Apricot
1FB6 Cumin
1FB7 Green Apple
1FB8 Slate Blue
1FB9 Metal

Proprietary Textile Colors – Workspaces

continued

Price Category 3

continued

Current

66" wide	
100% antimony-free polyester	
1FC1	Oyster
1FC2	Linen
1FC3	Iceberg
1FC4	Silver Pine
1FC5	Apricot
1FC6	Cumin
1FC7	Green Apple
1FC8	Slate Blue
1FC9	Metal

Glaze

66" wide	
100% recycled polyester	
8Z01	Wicker
8Z02	Honey
8Z03	Porcelain
8Z04	Celadon
8Z06	Rye
8Z07	Frost
8Z08	Silver Birch

Ground Cloth®

66" wide	
100% polyester	
4701	Vapor Grey
4721	Warm White *
4722	Fog *
4723	Straw *
4724	Red Orange *
4725	Wild Berry *
4726	Green Apple *
4727	Caribbean *
4728	Midnight *
4729	Cappuccino *

* Colors available on Exclave®
Video-friendly Tackable Boards
and Stowage Tackable Backdrop

Kira 2

54" wide	
100% recycled polyester	
5D11	Flaxen
5D12	Papyrus
5D13	Oasis
5D14	Incense
5D15	Ash
5D16	Falcon

Pins and Needles

58" wide	
76% recycled polyester	
24% polyester	
22R01	Day and Night
22R02	Night and Day

Savannah

66" wide	
76% recycled polyester	
24% polypropylene	
8L01	Pearl
8L02	Oyster
8L03	Wheat
8L04	Jute
8L05	Bamboo
8L06	Metal
8L07	Linen
8L08	Celadon
8L09	Moss
8L10	Frost
8L11	Shale
8L12	Pewter

Stitches

54" wide	
54% polyester	
46% recycled polyester	
8U02	Rye
8U03	Khaki
8U04	Honey
8U05	Cattail
8U06	Pumpkin
8U07	Brick
8U08	Cool Grey
8U09	Slate Blue
8U10	Juniper
8U11	Evening Blue
8U12	Charcoal
8U13	Kiwi Green
8U14	Olive
8U15	Pesto
8U16	Cocoa
8U17	Seed

Stitches

For workspaces products only.	
54" wide	
54% polyester	
46% recycled polyester	
5Z01	White Ash

Strands

66" wide	
100% recycled polyester	
8W01	Pebble
8W02	Porcelain
8W03	Taupe
8W04	Honey
8W05	Khaki
8W06	Rye
8W07	Wicker
8W08	Tin
8W09	Cool Grey

String Plaid

54" wide	
100% recycled polyester	
22V01	Warm White on Khaki
22V02	Mint on Yellow Green
22V03	Mist on Blue Grey
22V04	Sky Blue on Red
22V05	Lime on Magenta
22V06	Bright Green on Green
22V07	Aqua Blue on Cerulean
22V08	Ivory on Black

Proprietary Textile Colors – Workspaces

continued

Price Category 4

Glisten
66" wide
84% polyester
16% recycled polyester

- 2X02 Rye
- 2X05 Iceberg
- 2X09 Pewter
- 2X10 Ash

Loft
Assigned lead-time textile. A
54" wide
100% wool

- 22L01 Heathered Light Green
- 22L02 Heathered Dark Green
- 22L03 Heathered Turquoise
- 22L04 Heathered Navy
- 22L05 Heathered Orange
- 22L06 Heathered Red
- 22L07 Heathered Tan *
- 22L08 Heathered Grey *
- 22L09 Heathered Blue *
- 22L10 Heathered Brown
- 22L11 Heathered Dark Grey
- 22L12 Heathered Denim

* Colors available on Exclave®
Video-friendly Tackable Boards
and Stowage Tackable Backdrop

Quilty
56" wide
100% antimony-free polyester
GreenShield

- 6S03 Khaki
- 6S04 Straw
- 6S07 Brick
- 6S10 Mink
- 6S11 Green Apple
- 6S13 Indigo
- 6S14 Zinc
- 6S15 Slate
- 6S16 Beachwood
- 6S17 Paprika
- 6S18 Plum
- 6S19 Juniper
- 6S20 Grey Black

Sironetta
66" wide
100% recycled polyester

- 6301 Acapella
- 6302 Sonata
- 6303 Interlude
- 6304 Legato
- 6308 Harmony
- 6309 Ensemble

Price Category 5

Hopsak
56" wide
100% recycled polyester

- 14A20 Black
- 14A22 Raw Umber Dark
- 14A26 Grey Blue Dark
- 14A30 Sepia Dark
- 14A38 Emerald Dark
- 14A39 Yellow Dark
- 14A40 Orange
- 14A41 Sienna
- 14A42 Olive Green Dark
- 14A43 Crimson
- 14A44 Crimson Dark Dark
- 14A45 Violet Dark
- 14A46 Pink Dark Dark
- 14A47 Ultramarine Dark
- 14A48 Cobalt Blue
- 14A49 Terra Cotta
- 14A50 Ochre Dark

Maharam® Application Chart — Workspaces

•Available

See below for exception notes.

Maharam textiles are on assigned lead times. A

	Action Office® Panels/Connectors	Action Office/Ethospace® B-Style Storage	Action Office/Ethospace B-Style Tackboards	Action Office/Ethospace E-Style Storage	Ethospace Tiles/Connectors	Ethospace/Canvas Office Landscape® Privacy Doors	Canvas Tiles/Extended Width Tiles	Canvas B-/E-Style Storage	Canvas Tackboards	Locale® Freestanding Screen and Workbase Screen	Pari™ Screens	Public Office Landscape® Screen/Desk Top Divider	Renew™ Link Screens	Resolve® Boundary Screens/Flags	Resolve Display Screens	Resolve Rolling Screens/Canopies	Intersect® Screens	5000 Series Storage	5000 Series Tackboards	Seating
Price Category A																				
No fabrics available at this time.																				
Price Category B																				
VQ__ Crisp - Maharam	5	•	•	•	12		•	•	•									•	3	3
VM__ Medium - Maharam		2	2				•	20	•									•		3
TI__ Messenger - Maharam *		2	2	•	12	•	•	2	•										3	3
Price Category C																				
TT__ Parallel - Maharam	7	•	•		•	•	•	18	•									•		3
Price Category D																				
Z27__ Manner - Maharam	2	2	2	2	•		•	2	•										3	3
Z2R__ Reply - Maharam	•	•	•	•	•	•	•	•	•									•		3
ZS3__ Spiral - Maharam	•	•	•	•	•		•	•	•											
Z34__ Unit - Maharam	•						•	•	•										3	3
Price Category E																				
ZF3__ Flock - Maharam										•	•	•	•							
ZGT__ Glint - Maharam	2	2	2	2	2		•	2	•											
Z25__ Hum - Maharam	11	2		2	•		•	2											3	
ZMD__ Mode - Maharam	2																			•
Z3__ Metric - Maharam	2		2			•	•		•									•	3	3
ZM1__ Morse - Maharam	•	•	•	•	•		•	•	•											
Z32__ Skein - Maharam	2	2	2	2	•		•	2	•										3	3
ZSC__ Sketch - Maharam	•	•	•	•	•		•	•	•											
Price Category F																				
ZA1__ Adjourn - Maharam	•	•	•	•	•			•	•											
VS__ Crush - Maharam			2	•				19										•	3	3
Z29__ Plait - Maharam	2	2	2	2	•		•	2	•										3	3
ZS2__ Sharkskin 2 - Maharam	2	2	2	2	2		•	2	•											
Price Category G																				
ZT4__ Ticker - Maharam	2	2	2	2	2		•	2	•											•
Price Category H-Z																				
No fabrics available at this time.																				

Appendix: Maharam Application Chart — Workspaces

* Available in select colors on 20-day lead-time.
Refer to "Maharam Colors - Workspaces" for 20-day colors.

- 2 Available on all products except 54" and 60" wide.
- 3 Fabric is railroaded for all widths.
- 5 Not available on AO partial-glazed panels.
- 7 Not available on AO acoustical panels; not available on AO2 cable management panel face.
- 11 Available on AO products except 54" wide and 60" wide; not available on AO connectors.
- 12 Not available on Ethospace tackable tiles.
- 18 Not available on Canvas E-style storage.
- 19 Not available on Canvas B-style storage.
- 20 Not available on Canvas E-style storage or 60"-wide B-style storage.

Application Note: Herman Miller cannot guarantee material/pattern alignment in adjacent products. For example, a fabric's pattern may not align from one screen to the next, or from one panel to the next.



Maharam® Colors – Workspaces

Price Category A

No fabrics available at this time.

Price Category B

Crisp – Maharam

66" wide	
100% polyester	
VQ02/901420-002	Oyster
VQ05/901420-005	Quahaug
VQ13/901420-013	Admiral
VQ14/901420-014	Thunder
VQ21/901420-021	Graphite
VQ22/901420-022	Lychee
VQ23/901420-023	Persimmon
VQ24/901420-024	Kimchi
VQ25/901420-025	Marigold
VQ26/901420-026	Brut
VQ27/901420-027	Chartreuse
VQ28/901420-028	Celadon
VQ29/901420-029	Surf
VQ30/901420-030	Marble
VQ31/901420-031	Boulder
VQ32/901420-032	Bell
VQ33/901420-033	Ferry
VQ34/901420-034	Sapphire
VQ35/901420-035	Carbon
VQ36/901420-036	Owl
VQ37/901420-037	Agate

Medium – Maharam

54" wide	
100% polyester	
VM01/463490-001	Raven
VM02/463490-002	Smoke
VM03/463490-003	Alloy
VM04/463490-004	Flax
VM06/463490-006	Bark
VM07/463490-007	Espresso
VM08/463490-008	Pecan
VM12/463490-012	Pumpkin
VM13/463490-013	Persimmon
VM14/463490-014	Laser
VM16/463490-016	Port
VM22/463490-022	Marina
VM29/463490-029	Pistachio
VM32/463490-032	Prospect
VM36/463490-036	Delight
VM39/463490-039	Nautical
VM40/463490-040	Pool
VM44/463490-044	Washed
VM45/463490-045	Sculpture
VM46/463490-046	Thatched
VM47/463490-047	Hike
VM48/463490-048	Tangle
VM49/463490-049	Pacific
VM50/463490-050	Cosmic
VM51/463490-051	Cascade
VM52/463490-052	Blackberry
VM53/463490-053	Nasturtium
VM54/463490-054	Wooded

Messenger – Maharam

54" wide	
78% recycled polyester	
15% polyester, 7% nylon	
TI01/458640-001	Balsa
TI06/458640-006	Tobacco
TI07/458640-007	Shadow *
TI08/458640-008	Bayou *
TI10/458640-010	Zinc
TI24/458640-024	Poppy

Messenger *continued*

TI25/458640-025	Mao
TI29/458640-029	Onyx
TI31/458640-031	Cloud *
TI38/458640-038	Depth *
TI40/458640-040	Nile
TI41/458640-041	Azure *
TI45/458640-045	Cactus *
TI46/458640-046	Ice *
TI48/458640-048	Neon *
TI50/458640-050	Hydrangea *
TI51/458640-051	Lilac
TI52/458640-052	Chestnut
TI53/458640-053	Tangelo
TI54/458640-054	Lumine *
TI58/458640-058	Snow
TI59/458640-059	Fennel
TI60/458640-060	Peridot *
TI61/458640-061	Capri
TI62/458640-062	Ultramarine
TI63/458640-063	Squall
TI66/458640-066	Cassis
TI67/458640-067	Aster
TI68/458640-068	Spice
TI69/458640-069	Cherry
TI70/458640-070	Vibrant
TI71/458640-071	Satsuma *
TI72/458640-072	Maize
TI76/458640-076	Fossil
TI77/458640-077	Ash
TI78/458640-078	Tusk
TI79/458640-079	Oyster
TI80/458640-080	Pensive
TI81/458640-081	Husk
TI82/458640-082	Fireside
TI83/458640-083	Chili
TI84/458640-084	Robust
TI85/458640-085	Beyond
TI86/458640-086	Voyage
TI87/458640-087	Everglade
TI88/458640-088	Electric

* Colors available on 20-day lead time.

- Maharam textiles are on assigned lead times. [A](#)
- Fabric numbers are listed as Herman Miller fabric number/Maharam fabric number.

Maharam® Colors – Workspaces

continued

Price Category C

Parallel – Maharam	
66" wide	
100% recycled polyester	
TT01/901180-001	Chalk
TT02/901180-002	Argent
TT03/901180-003	Fog
TT11/901180-011	Cadet
TT17/901180-017	Sourdough
TT22/901180-022	Sterling
TT23/901180-023	Linen
TT24/901180-024	Pea

Price Category D

Manner - Maharam	
54" wide	
100% recycled polyester	
Z2701/466177-001	Magic
Z2702/466177-002	Carob
Z2703/466177-003	Porpoise
Z2704/466177-004	Flint
Z2705/466177-005	Hush
Z2706/466177-006	Nuance
Z2707/466177-007	Thicket
Z2708/466177-008	Cocoa
Z2709/466177-009	Pathway
Z2710/466177-010	Cola
Z2711/466177-011	Ember
Z2712/466177-012	Wagon
Z2713/466177-013	Ablaze
Z2714/466177-014	Peel
Z2715/466177-015	Penny
Z2716/466177-016	Butterscotch
Z2717/466177-017	Harvest
Z2718/466177-018	Lioness
Z2719/466177-019	Caper
Z2720/466177-020	Parakeet
Z2721/466177-021	Greenway
Z2722/466177-022	Aquatic
Z2723/466177-023	Cottage
Z2724/466177-024	Dahlia
Z2725/466177-025	Vivid
Z2726/466177-026	Basin
Z2727/466177-027	Schooner

Price Category E

Reply - Maharam	
66" wide	
100% polyester	
Z2R1/901880-001	Canvas
Z2R5/901880-005	Pewter
Z2R6/901880-006	Lapis
Z2RB/901880-011	Adobe
Z2RD/901880-013	Beacon

Spiral - Maharam	
66" wide	
100% polyester	
ZS301/901882-001	Chalk
ZS302/901882-002	Birch
ZS303/901882-003	Wheat
ZS304/901882-004	Mica
ZS305/901882-005	Pavement
ZS306/901882-006	Graphite

Unit - Maharam	
66" wide	
100% recycled polyester	
Z3401/901889-001	Seawall
Z3402/901889-002	Limestone
Z3403/901889-003	Aluminum
Z3404/901889-004	Snow
Z3405/901889-005	Tusk
Z3406/901889-006	Nautilus
Z3407/901889-007	Beech
Z3408/901889-008	Driftwood
Z3409/901889-009	Cocoa

Flock - Maharam	
63" wide	
100% polyester	
ZF301/901892-001	Calm
ZF302/901892-002	Course
ZF303/901892-003	Highlight
ZF304/901892-004	Roe
ZF305/901892-005	Poppy
ZF306/901892-006	Briefcase
ZF307/901892-007	Monkstrap
ZF308/901892-008	Quag
ZF309/901892-009	Pistachio
ZF310/901892-010	Froth
ZF311/901892-011	Celadon
ZF312/901892-012	Highsea
ZF313/901892-013	China
ZF314/901892-014	Victorian
ZF315/901892-015	Commander
ZF316/901892-016	Raven
ZF317/901892-017	Aluminum

Price Category E continued on next page

- Maharam textiles are on assigned lead times. A
- Fabric numbers are listed as Herman Miller fabric number/Maharam fabric number.

Maharam® Colors – Workspaces

continued

Price Category E

continued

Glint - Maharam

54" wide
59% polyolefin
32% post-industrial recycled polyester
9% post-consumer recycled polyester
PFOA-Free stain resistant finish
Acrylic backing
ZGT01/901380-001 Ice
ZGT02/901380-002 Oyster
ZGT03/901380-003 Aluminum
ZGT04/901380-004 Placid
ZGT05/901380-005 Patina
ZGT06/901380-006 Midas
ZGT07/901380-007 Medal

Hum - Maharam

54" wide
73% polyester
27% recycled polyester
Z2501/901890-001 Ash
Z2502/901890-002 Birch
Z2503/901890-003 Sandbar
Z2504/901890-004 Scallop
Z2505/901890-005 Kernel
Z2506/901890-006 Thyme
Z2507/901890-007 Caledon
Z2508/901890-008 Tide
Z2509/901890-009 Hearth
Z2510/901890-010 Postal
Z2511/901890-011 Briar
Z2512/901890-012 Molten

Metric – Maharam

54" wide
51% recycled polyester
49% polyester
Z301/466014-001 Phantom
Z302/466014-002 Fog
Z303/466014-003 Fleece
Z304/466014-004 Sourdough
Z305/466014-005 Toffee
Z306/466014-006 Driftwood
Z307/466014-007 Mineral
Z308/466014-008 Bittersweet
Z309/466014-009 Arabica
Z310/466014-010 Cerise
Z311/466014-011 Brick
Z312/466014-012 Cardinal
Z313/466014-013 Lava
Z314/466014-014 Oriole
Z315/466014-015 Cedar
Z317/466014-017 Caramel
Z318/466014-018 Pollen
Z319/466014-019 Tupelo
Z320/466014-020 Alligator
Z321/466014-021 Envy
Z322/466014-022 Bonsai
Z323/466014-023 Tar
Z324/466014-024 Anchor
Z325/466014-025 Twilight
Z326/466014-026 Admiral
Z327/466014-027 Seaport
Z328/466014-028 Scuba

Mode – Maharam

54" wide
80% post-consumer recycled polyester
20% polyester
PFOA-Free stain resistant finish
ZMD01/466337-001 Stroll
ZMD02/466337-002 Intaglio
ZMD03/466337-003 Ominous
ZMD04/466337-004 Machine

Mode continued

ZMD05/466337-005 Talus
ZMD06/466337-006 Marsh
ZMD07/466337-007 Hollow
ZMD08/466337-008 Sycamore
ZMD09/466337-009 Clavicle
ZMD10/466337-010 Billygoat
ZMD11/466337-011 Spindle
ZMD12/466337-012 Lemon
ZMD13/466337-013 Oxeye
ZMD14/466337-014 Henge
ZMD15/466337-015 Goldenrod
ZMD16/466337-016 Cottontail
ZMD17/466337-017 Lioness
ZMD18/466337-018 Oriole
ZMD19/466337-019 Rust
ZMD20/466337-020 Carotene
ZMD21/466337-021 Blush
ZMD22/466337-022 Vermillion
ZMD23/466337-023 Alder
ZMD24/466337-024 Kermes
ZMD25/466337-025 Barberry
ZMD26/466337-026 Petal
ZMD27/466337-027 Valley
ZMD28/466337-028 Odyssey
ZMD29/466337-029 Ballpoint
ZMD30/466337-030 Toile
ZMD31/466337-031 Paradise
ZMD32/466337-032 Angelfish
ZMD33/466337-033 Denim
ZMD34/466337-034 Crush
ZMD35/466337-035 Jetty
ZMD36/466337-036 Saltwater
ZMD37/466337-037 Mallard
ZMD38/466337-038 Celtic
ZMD39/466337-039 Eucalyptus
ZMD40/466337-040 Bonsai
ZMD41/466337-041 Sassafras
ZMD42/466337-042 Yucca
ZMD43/466337-043 Lichen

Morse - Maharam

66" wide
100% post-industrial recycled polyester
ZM101/901720-001 Talc
ZM104/901720-004 Cliff

Skein - Maharam

54" wide
56% recycled polyester
44% polyester
Z3201/466170-001 Burrow
Z3202/466170-002 Thatch
Z3204/466170-004 Sumac
Z3205/466170-005 Pomegranate
Z3206/466170-006 Cavern
Z3208/466170-008 Cinder
Z3209/466170-009 Dock
Z3210/466170-010 Cadet
Z3211/466170-011 Marsh

Sketch - Maharam

66" wide
52% post-consumer recycled polyester
48% post-industrial recycled polyester
ZSC01/901780-001 Macaroon
ZSC02/901780-002 Cashew
ZSC03/901780-003 Toffee
ZSC05/901780-005 Amber
ZSC06/901780-005 Carob
ZSC07/901780-007 Pewter
ZSC08/901780-008 Flue
ZSC09/901780-009 Abyss
ZSC12/901780-012 Zinc

- Maharam textiles are on assigned lead times. [A](#)
- Fabric numbers are listed as Herman Miller fabric number/Maharam fabric number.

Maharam® Colors – Workspaces

continued

Price Category F

Adjourn - Maharam	
72" wide	
57% polyester	
43% Trevira CS polyester	
ZA102/511350-002	Guava
ZA103/511350-003	Bran
ZA104/511350-004	Flax
ZA105/511350-005	Oatmeal
ZA109/511350-009	Terrain

Crush – Maharam	
54" wide	
88% nylon	
6% acrylic	
6% polyolefin	
VS01/464780-001	001
VS02/464780-002	002
VS05/464780-005	005
VS08/464780-008	008
VS13/464780-013	013
VS16/464780-016	016
VS17/464780-017	017
VS18/464780-018	018
VS19/464780-019	019
VS20/464780-020	020
VS22/464780-022	022
VS23/464780-023	023
VS26/464780-026	026
VS27/464780-027	027

Plait - Maharam	
58" wide	
68% recycled polyester	
32% polyester	
Z2901/466052-001	Cobblestone
Z2902/466052-002	Sachet
Z2903/466052-003	Mesa
Z2904/466052-004	Tavern
Z2905/466052-005	Sequoia
Z2906/466052-006	Rhubarb
Z2907/466052-007	Sangria
Z2908/466052-008	Reef
Z2909/466052-009	Stormy
Z2910/466052-010	Dapper

Sharkskin 2 - Maharam	
54" wide	
89% polyester	
11% solution-dyed polyester	
PFOA-Free stain resistant finish	
Acrylic backing	
ZS201/901650-033	Harmony
ZS202/901650-034	Suggestion
ZS203/901650-039	Lyric
ZS204/901650-040	Clarify
ZS205/901650-041	Remain
ZS206/901650-046	Sphere
ZS207/901650-051	Restore
ZS208/901650-054	Tawny
ZS209/901650-056	Frosted
ZS210/901650-057	Regal
ZS211/901650-058	Wash
ZS212/901650-059	Navy
ZS213/901650-060	Neon
ZS214/901650-061	Azalea

Price Category G

Ticker - Maharam	
54" wide	
47% polyester	
31% post-industrial recycled polyester	
22% post-consumer recycled polyester	
Crypton green finish and backing	
ZT401/466304-001	Calm
ZT402/466304-002	Millet
ZT403/466304-003	Sow
ZT404/466304-004	Beaver
ZT405/466304-005	Patch
ZT406/466304-006	Balloon
ZT407/466304-007	Squad
ZT408/466304-008	Bale
ZT409/466304-009	Fecund
ZT410/466304-010	Aquarium
ZT411/466304-011	Drink
ZT412/466304-012	Depth
ZT413/466304-013	Far

Price Category H-Z

No fabrics available at this time.

- Maharam textiles are on assigned lead times. A
- Fabric numbers are listed as Herman Miller fabric number/Maharam fabric number.

For more information about our products and services or to see a list of dealers, please visit us at HermanMiller.com or call (800) 851 1196.

© 2018 Herman Miller, Inc., Zeeland, Michigan

® **HermanMiller**, 3D Intelligent, AO, Action Office, Aeron, ArcSpan, Aside, Avall, Avive, Bubble Lamps, Canvas Office Landscape, Caper, Celle, Co/Struc, Daisyone, Distil, Eames, Eco-Dematerialized, Embody, Envelop, Equa 2, Ergon 3, Ethospace, Exclave, Fine-Tune, FlexFront, Flo, Formcoat, Formwork, Ground Cloth, Herman Miller for the Home, Herman Miller for Healthcare, Intersect, Kinemat, Lapjack, Layout Studio, Lifework, Limerick, Live Unframed, Living Office, Locale, Maharam, Meridian, Mirra, Passage, Pellicle, Perspectives, PostureFit, Public Office Landscape, Resolve, Rodney, Sayl, Setu, Thrive, Tu, Wishbone, and Y-Tower are among the registered trademarks of Herman Miller, Inc., and its owned subsidiaries.

™ 8Z Pellicle, About Face, AireWeave, Albert, Backfit, Bubbletack, Burdick Group, Butterfly Back, Celeste, Cellular Suspension, Clam, Compass, Connect, Cubert, DOT, Duracare, Durawrap, Eames Soft Pad, EnhancedAccess, Everywhere, Flex-Edge, Flute, Harmonic, Herman Miller Select, Hopsak 2, Intent, Iota, Jaw, Keyless Entry, Keyn Chair Group by Herman Miller, Latitude, Locale, Logic Mini, Logic Power Access Solutions, Live OS, Loop, Lyris, Lyris 2, Made-to-Measure Storage, Metaform Portfolio, Mora, Motia, Multiscrim, Nelson, Pari, Pixelated Support, Plex, PostureFit SL, Prospect, Q, Renew, Sense, Soft Pad, Stackable, Stackable Storage, Striad, Swoop, Tone, TriFlex, Twist, Ubi, Verus and Wireframe are among the trademarks of Herman Miller, Inc., and its owned subsidiaries.

SM Herman Miller Options is among the service marks of Herman Miller, Inc.

Alexander Girard® is a registered trademark of The Alexander Girard Estate.

Chemsur® is a registered trademark of Wilsonart International.

Corian® is a registered trademark of E. I. du Pont de Nemours and Company Corporation.

Crypton® is a registered trademark of Crypton, Inc.

DACRON® is a registered trademark of INVISTA S.a r.l.

Edelman® Leather is a registered trademark of Edelman Leather, Inc.

FENIX NTM® is a registered trademark of Arpa Industriale S.p.A.

FLEXNET™ is a trademark of Milliken & Company.

Floor Saver Glide® is a registered trademark of Carpin Manufacturing, Inc.

Geiger® is a registered trademark, and Bumper™, Saiba™, and Ward Bennett™ are trademarks, of Geiger International.

Goetz™ is a trademark of Mark W. Goetz.

Hang-It-All® is a registered trademark of Lucia Eames Demetrios, d.b.a. Eames Office.

Holophane® is a registered trademark of Holophane.

Ingeo™ is a trademark of Cargill Dow LLC.

iPad® is a registered trademark of Apple, Inc.

LifeSize® is a registered trademark of LifeSize Communications, Inc.

Magis®, Bombo®, and Me Too® are registered trademarks of Magis S.p.A.

Microsoft® and Natural® Keyboard are registered trademarks of Microsoft Corporation.

Noguchi® and the Noguchi table configuration (trade dress) are registered trademarks, and Rudder Table™ is a trademark, of The Isamu Noguchi Foundation and Garden Museum.

Place Textiles® is a registered trademark of Place Textiles.

SuperSeat™ is a trademark of Dahti Seating, a division of ITW.